



**LISTINO
PRICE LIST**

2018



ATHENA S.p.A.

BUSINESS UNIT

Athena Headquarters

Via delle Albere, 13
36045 Alonte - Vicenza (Italy)
Phone: +39 0444 727272
Fax: +39 0444 727222

Business Unit Nostrali

Via del Progresso, 21
36054 Montebello - Vicenza (Italy)
Phone: +39 0444 441200
Fax: +39 0444 441214

Business Unit Bluetech

Via delle Albere, 6
36045 Alonte - Vicenza (Italy)
Phone: +39 0444 727272
Fax: +39 0444 727222

Business Unit GET

Via delle Albere, 8
36045 Alonte - Vicenza (Italy)
Phone: +39 0444 727272
Fax: +39 0444 727292

Business Unit Erchie

Via Taranto - SS. 7 TER km. 34,500
72020 Erchie - Brindisi (Italy)
Phone: +39 0831 763700
Fax: +39 0831 767867

Athena USA, Inc.

2308 58th Ave East
Bradenton, FL - 34023 - USA
Phone: 1 855 741 2121
Fax: 1 631 244 0556

Athena INDIA

20B, 2nd Main, 2nd Phase
Peenya Industrial Area
Bangalore 560058 - India
Phone: +91 80 28395085/9976906257

Athena Motor Iberica

C/Joiers 17 Nave 7
08184 Palau Solità i Plegamans
Barcelona - Spagna
Phone: +34 935 744 857

Vedamotors

Estrada Blumenau, 2222 Bairro Bremer
Rio do Sul - SC - 89160-000 - Brasil
Phone: +55-47-3411 0500
Fax: +55-47-3411 0501

Athena Automotive and Industrial Parts Co. Ltd

Hangzhou City, XiaSha district,
Zhejiang province
(People Republic of China)

INDICE

INDEX

- 04 **Introduzione**
Introduction
- 06 **Parti metalliche**
Metal parts
- 18 **Stampati in gomma**
Rubber moulded parts
- 70 **Antivibranti**
Vibration dampings
- 80 **Accessori per oleodinamica**
Hydraulics accessories
- 114 **Fascette, rotolini, ptfe**
Cable ties, ptfe rolls
- 120 **Materiali per guarnizioni**
Sealing raw materials
- 128 **Collanti**
Adhesives



INTRODUZIONE
INTRODUCTION



UNA SOLIDA REALTÀ PRODUTTIVA A SOLID MANUFACTURING REALITY

Athena Industries Retail

Nasce da due grandi storie: quella commerciale di Bluetech, e quella industriale di Athena.

Unisce in un'unica realtà una lunga esperienza di mercato e una grande forza produttiva.

Tutta la qualità Athena, tutto il mondo della fornitura

Athena è leader nella produzione di componenti tecnici per l'industria vantando una gamma di oltre 150.000 prodotti e ben 14 tipologie di lavorazioni diverse. Un sistema flessibile e differenziato che garantisce un'offerta di articoli senza confronti in Europa e che assicura sempre la massima qualità.

Un partner solido per sostenere le vostre vendite

Conosce a fondo il mercato e si affianca ai punti vendita con un'amplissima gamma di prodotti e un servizio di consegna rapido e preciso.

Unico punto di riferimento per le richieste dei vostri clienti

Consente di ottimizzare gli ordini, i tempi e le risorse, aiutando a contenere i costi e a soddisfare ogni esigenza dei vostri clienti.

Un rapporto commerciale di successo

Basato sulla nostra organizzazione da un lato, e la vostra professionalità dall'altro. Insieme possiamo essere sempre più vicini ai consumatori, capire le loro esigenze e offrire un servizio sempre migliore.

Athena Retail Industries

Was founded following two concepts: the commercial one of Bluetech and the industrial one of Athena. It is the combination of a great market experience and a strong manufacturing force.

All Athena quality in a worldwide supply

Athena is a leading manufacturer company producing industrial components. With a wide range of over 150.000 products and 14 different services, it is characterised by a flexible and differentiated system that guarantees an unique range of products in Europe. Always ensuring the highest quality.

A strong partner to support your sales

Athena has a great understanding of the market and supplies the stores with a very wide range of products combined with a quick and efficient delivery service.

A single reference for your customer's requests

Athena maximizes profits through well organized time and resources, helping to keep low costs and to meet your customer's needs.

A successful business relationship

On one hand your professionalism and your company. On the other hand our organization skills. Together we can be closer to the customers, we can understand their needs and provide them a better service for a continuous growth and to increase our success.



PARTI METALLICHE
METAL PARTS

RONDELLE IN METALLO E GOMMA

BONDED SEALS

Le Bonded Seals sono rondelle in metallo con un elemento a tenuta di forma trapezoidale vulcanizzato nel diametro interno. Attraverso il serraggio, l'elastomero si comprime generando l'effetto di tenuta bloccando la perdita di liquido e di pressione all'esterno. La versione autocentrante garantisce il corretto posizionamento della Bonded durante il montaggio. Le Bonded Seals sono usate come guarnizioni statiche nei raccordi e nelle flangie. I materiali che compongono la tenuta sono NBR e rondella metallica acciaio SAE 1008 (1.0330), acciaio inossidabile AISI 304 (1.4301), rivestimento della rondella in zinco (esente da cromo esavalente). La pressione massima di esercizio dipende dalla forma della guarnizione, dal materiale e dalle dimensioni, dalle superfici di contatto e dalla forza di serraggio. Le Bonded Seals garantiscono la tenuta fino a 25 MPa di pressione senza la creazione di un'apposita sede. Ulteriori tipologie speciali, come quelle con elastomero in FKM o HNBR, sono disponibili su richiesta.

The Bonded Seals are metal washers with a sealing element in a trapezoidal shape cured in the inner diameter. By tightening, the elastomer is compressed, generating the sealing effect and preventing the leakage of liquid and pressure on the outside. The self centring version ensures the correct positioning of the Bonded Seal during the assembly process. The Bonded Seals are used as static seals in the fittings and flanges. They are made of NBR and metal washer steel SAE 1008 (1.0330), stainless steel AISI 304 (1.4301), washer zinc coating (no hexavalent chromium). The maximum operating pressure depends on the shape of the gasket, on the material and size, on the contact surfaces and on the sealing force. The Bonded Seals guarantee the seal up to 25 MPa of pressure without the creation of a suitable seat. Special types, such as those with FKM or HNBR elastomer may be available upon request.



BONDED NBR STANDARD
STANDARD BONDED SEALS



Codice Code	d. mm	D mm	H mm	Gas Metric	Conf. Standard Standard Package	Prezzo Unit Price
S739907471000	4,50	7,00	1,00	M4	100	€ 0,3086
S739907523000	5,21	8,38	1,22		100	€ 0,1488
S739907400000	5,70	9,00	1,00	M5	100	€ 0,3026
S739907478000	6,70	11,00	1,00	M6	100	€ 0,3283
S739907524000	6,86	13,21	1,22		100	€ 0,1765
S739907526000	8,64	14,22	1,22		100	€ 0,1932
S739907477000	8,70	13,00	1,00	M8	100	€ 0,3364
S739907527000	10,37	15,88	2,03	1/8"	100	€ 0,1662
S739907486000	10,70	16,00	1,50	M10	100	€ 0,3603
S739907493000	12,70	20,00	1,50	M12	100	€ 0,3909
S739907530000	13,74	20,57	2,03	1/4"	100	€ 0,1713
S739907496000	14,70	22,00	1,50	M14	100	€ 0,4596
S739907531000	14,86	22,23	2,03		100	€ 0,2531
S739907532000	15,83	22,23	2,03		100	€ 0,2531
S739907534000	16,51	25,40	2,03		100	€ 0,5070
S739907498000	16,70	24,00	1,50	M16	100	€ 0,4334
S739907533000	17,28	23,80	2,03	3/8"	100	€ 0,1919
S739907501000	18,70	26,00	1,50	M18	100	€ 0,5164
S739907536000	19,69	26,92	2,34		100	€ 0,2834
S739907502000	20,70	28,00	1,50	M20	100	€ 0,4720
S739907537000	21,54	28,58	2,34	1/2"	100	€ 0,2318
S739907504000	22,70	30,00	2,00	M22	100	€ 0,5996
S739907538000	23,49	31,75	2,50	5/8"	100	€ 0,3053
S739907506000	24,70	32,00	2,00	M24	100	€ 0,6067
S739907539000	24,26	33,27	2,50		100	€ 0,3523
S739907507000	26,70	35,00	2,00	M26	100	€ 0,6304
S739907540000	27,05	34,93	2,34	3/4"	100	€ 0,3040
S739907509201	28,70	37,00	2,00	M28	100	€ 0,6548
S739907530700	30,70	39,00	2,00	M30	100	€ 0,6851
S739907543000	30,81	38,10	2,34	7/8"	100	€ 0,4630
S739907545000	33,89	42,80	3,25	1"	100	€ 0,5725
S739907546000	35,94	44,45	3,25		100	€ 0,7483
M739907546500	36,70	46,00	2,00	M36	100	€ 0,8555
S739907670000	38,96	47,75	3,25	M38	100	€ 1,1647
S739907548000	42,93	52,38	3,25	1 1/4"	100	€ 0,7908
S739907550000	48,44	58,60	3,25	1 1/2"	100	€ 0,9402
S739907552000	54,89	69,85	3,25	1 3/4"	100	€ 1,4973
S739907554000	60,58	73,03	3,25	2"	100	€ 1,4013

BONDED NBR AUTOCENTRANTI
SELF CENTR. BONDED SEALS

Codice Code	d. mm	D mm	H mm	Gas Metric	Conf. Standard Standard Package	Prezzo Unit Price
M739907471001	4,50	7,00	1,00	M4	100	€ 0,3351
S739907400001	5,70	9,00	1,00	M5	100	€ 0,3359
S739907478001	6,70	11,00	1,00	M6	100	€ 0,3359
S739907526001	8,64	14,22	1,22		100	€ 0,1951
S739907477001	8,70	13,00	1,00	M8	100	€ 0,3643
S739907527001	10,37	15,88	2,03	1/8	100	€ 0,1662
S739907532001	10,70	16,00	1,50	M10	100	€ 0,3871
S739907489001	12,70	18,00	1,50	M12	100	€ 0,4704
S739907530001	13,74	20,57	2,03	1/4	100	€ 0,1713
S739907531001	14,86	22,23	2,03		100	€ 0,2834
S739907495001	14,70	22,00	1,50	M14	100	€ 0,4978
S739907534001	16,51	25,40	2,03		100	€ 0,5070
S739907498001	16,70	24,00	1,50	M16	100	€ 0,4689
S739907533001	17,28	23,80	2,03	3/8	100	€ 0,1919
S739907539001	18,70	26,00	1,50	M18	100	€ 0,5581
S739907536001	19,69	26,92	2,34		100	€ 0,4888
S739907502001	20,70	28,00	1,50	M20	100	€ 0,5134
S739907537001	21,54	28,58	2,34	1/2	100	€ 0,2318
S739907504001	22,70	30,00	2,00	M22	100	€ 0,7100
S739907538001	23,49	31,75	2,34	5/8	100	€ 0,3053
S739907506001	24,70	32,00	2,00	M24	100	€ 0,7219
S739907507001	26,70	35,00	2,00	M26	100	€ 1,1893
S739907540001	27,05	34,93	2,34	3/4	100	€ 0,3040
S739907543001	30,81	38,10	2,34	7/8	100	€ 0,4630
S739907530701	30,70	39,00	2,00	M30	100	€ 1,2254
S739907545001	33,89	42,80	3,25	1"	100	€ 0,5725
S739907548001	42,93	52,38	3,25	1 1/4"	100	€ 0,7908
S739907550001	48,44	58,60	3,25	1 1/2"	100	€ 0,9402
M739907552001	54,89	69,85	3,25	1 3/4"	100	€ 2,3200
S739907554001	60,58	73,03	3,25	2"	100	€ 1,4013

BONDED INOX STANDARD
STANDARD SS BONDED SEALS



Codice Code	d. mm	D mm	H mm	gas metric	Conf. Standard Standard Package	Prezzo Unit Price
M739907527010	10,37	15,88	2,03	1/8"	100	€ 1,4490
S739907530010	13,74	20,57	2,03	1/4"	100	€ 1,5215
S739907533010	17,28	23,80	2,03	3/8"	100	€ 1,6664
S739907537010	21,54	28,58	2,50	1/2"	100	€ 3,1878
S739907540010	27,05	34,93	2,34	3/4"	100	€ 5,9409
S739907545010	33,89	42,80	2,50	1"	100	€ 7,5348
S739907548010	42,93	52,38	2,50	1 1/4"	100	€ 11,9543
S739907550010	48,44	58,60	2,50	1 1/2"	100	€ 13,4033
S739907554002	60,58	73,03	2,50	2"	100	€ 24,9953

BONDED INOX AUTOCENTRANTI
SELF CENTR. SS BONDED SEALS



Codice Code	d. mm	D mm	H mm	gas metric	Conf. Standard Standard Package	Prezzo Unit Price
S739907527003	10,37	15,88	2,00	1/8"	100	€ 1,4490
S739907530003	13,74	20,57	2,00	1/4"	100	€ 1,5215
S739907533003	17,28	23,80	2,00	3/8"	100	€ 1,6664
S739907537003	21,54	28,58	2,50	1/2"	100	€ 3,1878
S739907540003	27,05	34,93	2,50	3/4"	100	€ 5,9409
S739907545003	33,89	42,80	2,50	1"	100	€ 7,5348
S739907548003	42,93	52,38	2,50	1 1/4"	100	€ 11,9543
S739907550003	48,84	58,60	2,50	1 1/2"	100	€ 13,4033
S739907554003	60,58	73,03	2,50	2"	100	€ 24,9953

RONDELLE IN RAME E IN ALLUMINIO COPPER AND ALUMINIUM WASHERS

Rappresentano la soluzione più semplice ed economica ai problemi di serraggio o di tenuta. Altissima precisione, ottime finiture e materie prime di elevata qualità sono le principali caratteristiche delle rondelle a marchio Athena. La loro buona deformabilità garantisce una buona tenuta in presenza di pressioni non molto elevate. Disponibili a magazzino in tutte le dimensioni standard con spessori da 1 a 1,5 mm, possono essere prodotte, su richiesta, anche in dimensioni diverse. Le rondelle in rame e in alluminio vengono anche fornite in kit assortiti dentro solide cassette a scomparti normalmente utilizzate per manutenzioni o ricambi.

They represent the simplest and the cheapest solution for tightening or sealing problems. High precision, high quality raw materials and finishes are the main characteristics of our washers. Their good deformability ensures sufficient stability in the presence of a medium low pressure. Available in stock in all standard sizes with thickness from 1 to 1.5 mm, they can be provided, upon request, in different sizes. Copper and aluminium washers are also supplied in assorted kits contained in solid boxes with compartments, normally used for maintenance or spare parts.

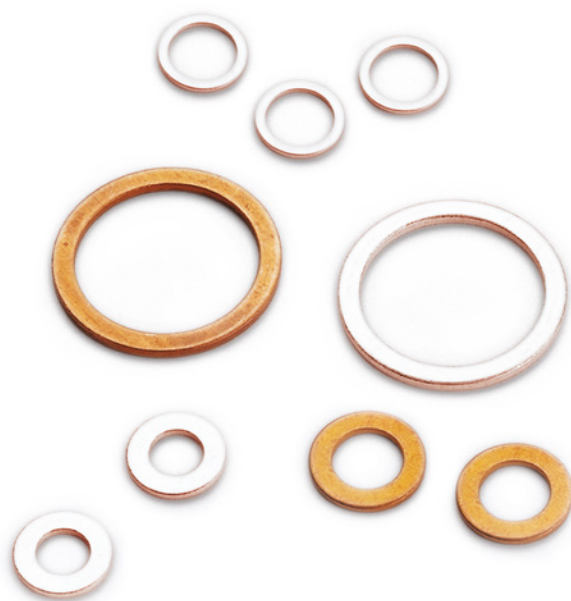

RONDELLE IN RAME 1 mm
COPPER WASHER 1 mm



Codice conf.standard Code standard package	Q.tà Q.ty	Prezzo Unit Price	Codice conf.mini Code small package	Q.tà Q.ty	Prezzo Unit Price	Spessore Thick 1.5 mm		Ø Gas Gas thread size
						di/inner ø	de/outer ø	
M700106010010	1000	€ 0,0369	M700106010010/1	100	€ 0,0401	6	10	-
M700106012010	1000	€ 0,0472	M700106012010/1	100	€ 0,0505	6	12	-
M700108012010	1000	€ 0,0412	M700108012010/1	100	€ 0,0445	8	12	-
M700108014010	1000	€ 0,0559	M700108014010/1	100	€ 0,0591	8	14	-
M700108016010	1000	€ 0,0689	M700108016010/1	100	€ 0,0722	8	16	-
M700110014010	1000	€ 0,0515	M700110014010/1	100	€ 0,0548	10	14	1/8"
M700110016010	1000	€ 0,0673	M700110016010/1	100	€ 0,0705	10	16	1/8"
M700110018010	1000	€ 0,0846	M700110018010/1	100	€ 0,0879	10	18	1/8"
M700110020010	1000	€ 0,1226	M700110020010/1	100	€ 0,1259	10	20	1/8"
M700112016010	1000	€ 0,0618	M700112016010/1	100	€ 0,0651	12	16	-
M700112018010	1000	€ 0,0765	M700112018010/1	100	€ 0,0797	12	18	-
M700112020010	1000	€ 0,0966	M700112020010/1	100	€ 0,0998	12	20	-
M700113518010	1000	€ 0,0760	M700113518010/1	100	€ 0,0792	13,5	18	1/4"
M700113519010	1000	€ 0,0830	M700113519010/1	100	€ 0,0863	13,5	19	1/4"
M700113520010	1000	€ 0,0960	M700113520010/1	100	€ 0,0993	13,5	20	1/4"
M700114018010	1000	€ 0,0760	M700114018010/1	100	€ 0,0792	14	18	-
M700114020010	1000	€ 0,0890	M700114020010/1	100	€ 0,0922	14	20	-
M700114022010	1000	on request	M700114022010/1	100	on request	14	22	-
M700116020010	1000	€ 0,0868	M700116020010/1	100	€ 0,0901	16	20	-
M700116022010	1000	€ 0,1069	M700116022010/1	100	€ 0,1101	16	22	-
M700116024010	1000	€ 0,2110	M700116024010/1	100	€ 0,2143	16	24	-
M700116026010	1000	on request	M700116026010/1	100	on request	16	26	-
M700117022010	1000	€ 0,1069	M700117022010/1	100	€ 0,1101	17	22	3/8"
M700117023010	1000	€ 0,1134	M700117023010/1	100	€ 0,1166	17	23	3/8"
M700118022010	1000	€ 0,1069	M700118022010/1	100	€ 0,1101	18	22	-
M700118024010	1000	€ 0,1199	M700118024010/1	100	€ 0,1231	18	24	-
M700118026010	1000	€ 0,1508	M700118026010/1	100	€ 0,1541	18	26	-
M700120026010	1000	€ 0,1340	M700120026010/1	100	€ 0,1373	20	26	-
M700120028010	1000	€ 0,1703	M700120028010/1	100	€ 0,1736	20	28	-
M700120030010	1000	€ 0,1931	M700120030010/1	100	€ 0,1964	20	30	-
M700121526010	1000	€ 0,1378	M700121526010/1	100	€ 0,1411	21,5	26	1/2"
M700121527010	1000	€ 0,1411	M700121527010/1	100	€ 0,1443	21,5	27	1/2"
M700121528010	1000	€ 0,1817	M700121528010/1	100	€ 0,1850	21,5	28	1/2"
M700122026010	1000	€ 0,1335	M700122026010/1	100	€ 0,1367	22	26	-
M700122028010	500	€ 0,1508	M700122028010/1	100	€ 0,1541	22	28	-
M700122030010	500	€ 0,1828	M700122030010/1	100	€ 0,1861	22	30	-

RONDELLE IN RAME 1 mm
COPPER WASHER 1 mm

Codice conf.standard Code standard package	Q.tà Q.ty	Prezzo Unit Price	Codice conf.mini Code small package	Q.tà Q.ty	Prezzo Unit Price	Spessore Thick 1.5 mm		Ø Gas Gas thread size
						di/inner ø	de/outer ø	
M700124030010	500	€ 0,1709	M700124030010/1	100	€ 0,1741	24	30	5/8"
M700124032010	500	on request	M700124032010/1	100	on request	24	32	5/8"
M700126032010	500	€ 0,1931	M700126032010/1	100	€ 0,1964	26	32	-
M700127033010	500	€ 0,2029	M700127033010/1	100	€ 0,2062	27	33	3/4"
M700128034010	500	€ 0,2110	M700128034010/1	100	€ 0,2143	28	34	-
M700130036010	500	€ 0,2398	M700130036010/1	100	€ 0,2430	30	36	-
M700132038010	500	€ 0,2631	M700132038010/1	100	€ 0,2664	32	38	-
M700132040010	500	on request	M700132040010/1	100	on request	32	40	-
M700133540010	100	€ 0,8577			0,0000	33,5	40	1"
M700140548010	100	on request			0,0000	40,5	48	-
M700142050010	100	on request			0,0000	42	50	1"1/4
M700148055010	100	on request			0,0000	48	55	1"1/2

RONDELLE IN RAME 1,5 mm
COPPER WASHER 1,5 mm



Codice conf.standard Code standard package	Q.tà Q.ty	Prezzo Unit Price	Codice conf.mini Code small package	Q.tà Q.ty	Prezzo Unit Price	Spessore Thick 1.5 mm		Ø Gas Gas thread size
						di/inner ø	de/outer ø	
M700106010015	1000	€ 0,0488	M700106010015/1	100	€ 0,0521	6	10	-
M700106012015	1000	€ 0,0629	M700106012015/1	100	€ 0,0662	6	12	-
M700108012015	1000	€ 0,0564	M700108012015/1	100	€ 0,0597	8	12	-
M700108014015	1000	€ 0,0776	M700108014015/1	100	€ 0,0808	8	14	-
M700108016015	1000	€ 0,0966	M700108016015/1	100	€ 0,0998	8	16	-
M700110014015	1000	€ 0,0716	M700110014015/1	100	€ 0,0749	10	14	1/8"
M700110016015	1000	€ 0,0911	M700110016015/1	100	€ 0,0944	10	16	1/8"
M700110018015	1000	€ 0,1145	M700110018015/1	100	€ 0,1177	10	18	1/8"
M700110020015	1000	€ 0,1411	M700110020015/1	100	€ 0,1443	10	20	1/8"
M700112016015	1000	€ 0,0868	M700112016015/1	100	€ 0,0901	12	16	-
M700112018015	1000	€ 0,1085	M700112018015/1	100	€ 0,1118	12	18	-
M700112020015	1000	€ 0,1335	M700112020015/1	100	€ 0,1367	12	20	-
M700113518015	1000	€ 0,1085	M700113518015/1	100	€ 0,1118	13,5	18	1/4"
M700113519015	1000	€ 0,1166	M700113519015/1	100	€ 0,1199	13,5	19	1/4"
M700113520015	1000	€ 0,1340	M700113520015/1	100	€ 0,1373	13,5	20	1/4"
M700114018015	1000	€ 0,1052	M700114018015/1	100	€ 0,1085	14	18	-
M700114020015	1000	€ 0,1259	M700114020015/1	100	€ 0,1291	14	20	-
M700114022015	1000	€ 0,1660	M700114022015/1	100	€ 0,1693	14	22	-
M700116020015	1000	€ 0,1221	M700116020015/1	100	€ 0,1253	16	20	-
M700116022015	1000	€ 0,1530	M700116022015/1	100	€ 0,1562	16	22	-
M700116024015	1000	€ 0,1877	M700116024015/1	100	€ 0,1910	16	24	-
M700116026015	1000	€ 0,2192	M700116026015/1	100	€ 0,2224	16	26	-
M700117022015	1000	€ 0,1508	M700117022015/1	100	€ 0,1541	17	22	3/8"
M700117023015	1000	€ 0,1774	M700117023015/1	100	€ 0,1807	17	23	3/8"
M700118022015	1000	€ 0,1497	M700118022015/1	100	€ 0,1530	18	22	-
M700118024015	1000	€ 0,1725	M700118024015/1	100	€ 0,1758	18	24	-
M700118026015	1000	€ 0,2170	M700118026015/1	100	€ 0,2203	18	26	-
M700120026015	1000	€ 0,1948	M700120026015/1	100	€ 0,1980	20	26	-
M700120028015	1000	€ 0,2403	M700120028015/1	100	€ 0,2436	20	28	-
M700120030015	1000	€ 0,2788	M700120030015/1	100	€ 0,2821	20	30	-
M700121526015	1000	€ 0,1964	M700121526015/1	100	€ 0,1996	21,5	26	1/2"
M700121527015	1000	€ 0,2062	M700121527015/1	100	€ 0,2094	21,5	27	1/2"
M700121528015	1000	€ 0,2333	M700121528015/1	100	€ 0,2365	21,5	28	1/2"
M700122026015	1000	€ 0,1915	M700122026015/1	100	€ 0,1948	22	26	-
M700122028015	500	€ 0,2192	M700122028015/1	100	€ 0,2224	22	28	-
M700122030015	500	€ 0,2604	M700122030015/1	100	€ 0,2637	22	30	-

RONDELLE IN RAME 1,5 mm
COPPER WASHER 1,5 mm

Codice conf.standard Code standard package	Q.tà Q.ty	Prezzo Unit Price	Codice conf.mini Code small package	Q.tà Q.ty	Prezzo Unit Price	Spessore Thick 1.5 mm		Ø Gas Gas thread size
						di/inner ø	de/outer ø	
M700124030015	500	€ 0,2468	M700124030015/1	100	€ 0,2501	24	30	5/8"
M700124032015	500	€ 0,2908	M700124032015/1	100	€ 0,2940	24	32	5/8"
M700126032015	500	€ 0,2788	M700126032015/1	100	€ 0,2821	26	32	-
M700127033015	500	€ 0,2908	M700127033015/1	100	€ 0,2940	27	33	3/4"
M700128034015	500	€ 0,3060	M700128034015/1	100	€ 0,3092	28	34	-
M700130036015	500	€ 0,3494	M700130036015/1	100	€ 0,3526	30	36	-
M700132038015	500	€ 0,3841	M700132038015/1	100	€ 0,3873	32	38	-
M700132040015	500	€ 0,4280	M700132040015/1	100	€ 0,4313	32	40	-
M700133540015	100	€ 0,4280			0,0000	33,5	40	1"
M700140548015	100	€ 0,5506			0,0000	40,5	48	-
M700142050015	100	€ 0,5284			0,0000	42	50	1"1/4
M700148056015	100	€ 0,9461			0,0000	48	55	1"1/2
M700160068015	100	€ 1,4387			0,0000	60	68	2"
M700175088015	100	€ 6,1682			0,0000	75	88	2"1/2

RONDELLE IN ALLUMINIO 1,5 mm
ALLUMINIUM WASHER 1,5 mm



Codice conf.standard Code standard package	Q.tà Q.ty	Prezzo Unit Price	Codice conf.mini Code small package	Q.tà Q.ty	Prezzo Unit Price	Spessore Thick 1.5 mm		Ø Gas Gas thread size
						di/inner ø	de/outer ø	
M703406010015	1000	€ 0,0203	M703406010015/1	100	€ 0,0235	6	10	-
M703406012015	1000	€ 0,0245	M703406012015/1	100	€ 0,0277	6	12	-
M703408012015	1000	€ 0,0233	M703408012015/1	100	€ 0,0266	8	12	-
M703408014015	1000	€ 0,0269	M703408014015/1	100	€ 0,0301	8	14	-
M703408016015	1000	€ 0,0346	M703408016015/1	100	€ 0,0379	8	16	-
M703410014015	1000	€ 0,0257	M703410014015/1	100	€ 0,0289	10	14	1/8"
M703410016015	1000	€ 0,0298	M703410016015/1	100	€ 0,0331	10	16	1/8"
M703410018015	1000	€ 0,0358	M703410018015/1	100	€ 0,0391	10	18	1/8"
M703410020015	1000	€ 0,0471	M703410020015/1	100	€ 0,0504	10	20	1/8"
M703412016015	1000	€ 0,0286	M703412016015/1	100	€ 0,0319	12	16	-
M703412018015	1000	€ 0,0340	M703412018015/1	100	€ 0,0373	12	18	-
M703412020015	1000	€ 0,0400	M703412020015/1	100	€ 0,0433	12	20	-
M703413518015	1000	€ 0,0346	M703413518015/1	100	€ 0,0379	13,5	18	1/4"
M703413519015	1000	€ 0,0382	M703413519015/1	100	€ 0,0415	13,5	19	1/4"
M703413520015	1000	€ 0,0412	M703413520015/1	100	€ 0,0444	13,5	20	1/4"
M703414018015	1000	€ 0,0412	M703414018015/1	100	€ 0,0444	14	18	-
M703414020015	1000	€ 0,0364	M703414020015/1	100	€ 0,0397	14	20	-
M703414022015	1000	€ 0,0477	M703414022015/1	100	€ 0,0510	14	22	-
M703416020015	1000	€ 0,0382	M703416020015/1	100	€ 0,0415	16	20	-
M703416022015	1000	€ 0,0412	M703416022015/1	100	€ 0,0444	16	22	-
M703416024015	1000	€ 0,0483	M703416024015/1	100	€ 0,0516	16	24	-
M703416026015	1000	€ 0,0621	M703416026015/1	100	€ 0,0653	16	26	-
M703417022015	1000	€ 0,0430	M703417022015/1	100	€ 0,0462	17	22	3/8"
M703417023015	1000	€ 0,0477	M703417023015/1	100	€ 0,0510	17	23	3/8"
M703418022015	1000	€ 0,0442	M703418022015/1	100	€ 0,0475	18	22	-
M703418024015	1000	€ 0,0465	M703418024015/1	100	€ 0,0498	18	24	-
M703418026015	1000	€ 0,0615	M703418026015/1	100	€ 0,0647	18	26	-
M703420026015	1000	€ 0,0519	M703420026015/1	100	€ 0,0551	20	26	-
M703420028015	1000	€ 0,0662	M703420028015/1	100	€ 0,0695	20	28	-
M703420030015	1000	€ 0,0770	M703420030015/1	100	€ 0,0802	20	30	-
M703421526015	1000	€ 0,0585	M703421526015/1	100	€ 0,0617	21,5	26	1/2"
M703421527015	1000	€ 0,0543	M703421527015/1	100	€ 0,0575	21,5	27	1/2"
M703421528015	1000	€ 0,0639	M703421528015/1	100	€ 0,0671	21,5	28	1/2"
M703422026015	1000	€ 0,0567	M703422026015/1	100	€ 0,0600	22	26	-
M703422028015	500	€ 0,0567	M703422028015/1	100	€ 0,0600	22	28	-
M703422030015	500	€ 0,0728	M703422030015/1	100	€ 0,0760	22	30	-
M703423030015	500	€ 0,0728	M703423030015/1	100	€ 0,0760	23	30	5/8"
M703424030015	500	€ 0,0644	M703424030015/1	100	€ 0,0677	24	30	5/8"
M703424032015	500	€ 0,0776	M703424032015/1	100	€ 0,0809	24	32	5/8"

RONDELLE IN ALLUMINIO 1,5 mm
ALLUMINIUM WASHER 1,5 mm



Codice conf.standard Code standard package	Q.tà Q.ty	Prezzo Unit Price	Codice conf.mini Code small package	Q.tà Q.ty	Prezzo Unit Price	Spessore Thick 1.5 mm		Ø Gas Gas thread size
						di/inner ø	de/outer ø	
M703427033015	500	€ 0,0776	M703427033015/1	100	€ 0,0809	27	33	3/4"
M703428034015	500	€ 0,0800	M703428034015/1	100	€ 0,0833	28	34	-
M703430036015	500	€ 0,0859	M703430036015/1	100	€ 0,0891	30	36	-
M703432038015	500	€ 0,0967	M703432038015/1	100	€ 0,1000	32	38	-
M703432040015	500	on request	M703432040015/1	100	on request	32	40	-
M703433540015	100	€ 0,1020			€ 0,0000	33,5	40	1"
M703440548015	100	€ 0,1599			€ 0,0000	40,5	48	-
M703442050015	100	€ 0,1599			€ 0,0000	42	50	1 1/4
M703448056015	100	€ 0,2721			€ 0,0000	48	55	1 1/2
M703460068015	100	on request			€ 0,0000	60	68	2"
M703475088015	100	on request			€ 0,0000	75	88	2 1/2

KIT RONDELLE IN RAME
COPPER WASHERS KIT



KIT RONDELLE IN ALLUMINIO
ALLUMINIUM WASHERS KIT



Codice Code		Prezzo Unit Price	
M511099500000		€ 62,58	
Descrizione Kit Kit Description			
Misura Size	Q.tà Q.ty	Misura Size	Q.tà Q.ty
6x10x1	50	6x12x1	50
8x12x1	50	8x14x1	50
10x14x1	50	10x14x1,5	25
10x16x1,5	25	12x16x1,5	14
12x18x1,5	13	13x18x1,5	13
14x20x1,5	10	16x22x1,5	10
17x22x1,5	10	18x24x1,5	10
20x26x1,5	10	22x28x1,5	10

Codice Code		Prezzo Unit Price	
M602099500000		€ 38,80	
Descrizione Kit Kit Description			
Misura Size	Q.tà Q.ty	Misura Size	Q.tà Q.ty
6x10x1	50	6x12x1	50
8x12x1	50	8x14x1	50
10x14x1	50	10x14x1,5	25
10x16x1,5	25	12x16x1,5	14
12x18x1,5	13	13x18x1,5	13
14x20x1,5	10	16x22x1,5	10
17x22x1,5	10	18x24x1,5	10
20x26x1,5	10	22x28x1,5	10

STAMPATI IN GOMMA
RUBBER MOULDED PARTS



O-RINGS

Guarnizioni toroidali di nostra produzione disponibili in tutti i tipi di mescole e in tutte le dimensioni possibili, standard e metriche. Costituiscono una soluzione di tenuta ottimale sia statica che dinamica, per tutti i tipi di fluidi, anche in presenza di pressione. Le più recenti tecnologie, l'attenta scelta delle materie prime e la specializzazione degli addetti ci permettono di offrire alla clientela quanto di meglio esiste nella produzione degli O-rings.

Toroidal gaskets manufactured by Athena in all types of compounds and in all possible sizes, standard and metrics. They are the best sealing solution, either static or dynamic, for all types of fluids, even in the presence of pressure. The most recent technologies, a careful selection of raw materials and the experience of the staff allow us to offer our customers the best range of O-Rings on the market.

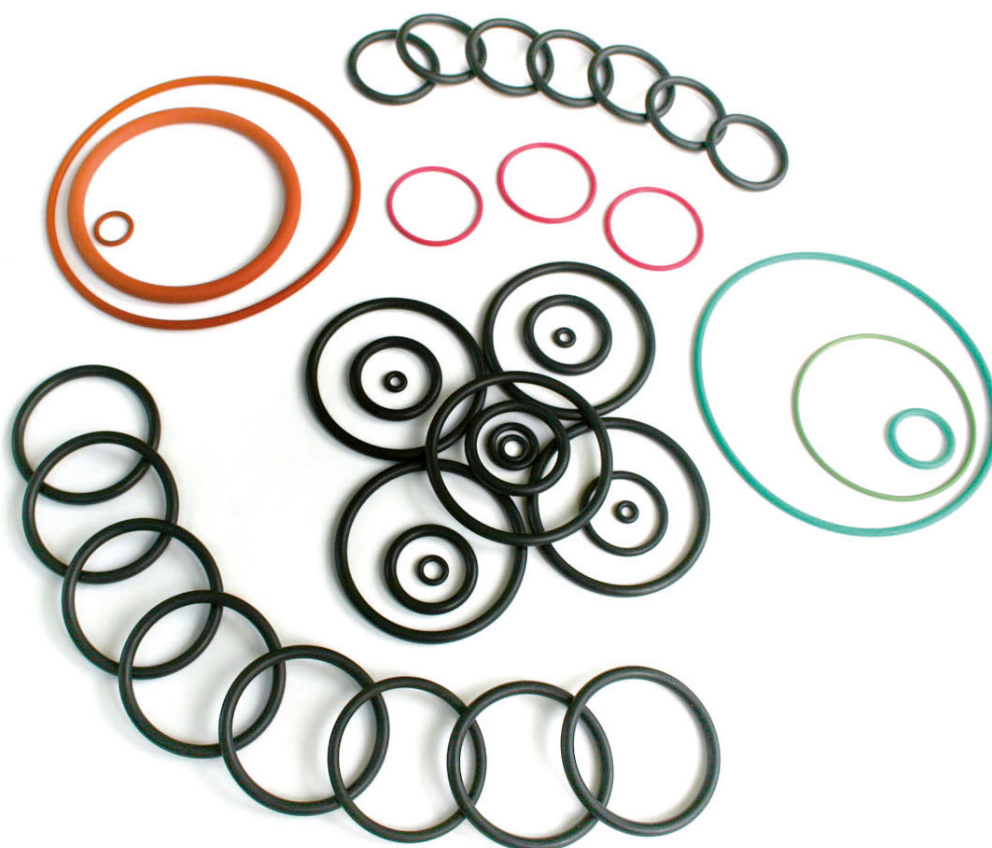

INFORMAZIONI TECNICHE GENERALI SUGLI O-RINGS

O-RINGS MAIN TECHNICAL DETAILS

Sigla Internazionale International Designation	Elastomero Base Basic Elastomer	Durezza Hardness	Resistenza a Trazione Tensile Strength	Allungamento a Rottura Elongation at Break	Deformazione permanente a Compressione Compression Set	Temperatura Impiego Working Temperature	Applicazioni e campi d'impiego Applications and fields of use
		(SH A)	(KG / CM2)	(%)	(%)	(°C)	
NBR	Copolimero Butadieneacrilotrinitile (Buna)	60±5	125	125	100°C-70h=8,5	-25 +100	Per tenute statiche e dinamiche in presenza di idrocarburi alifatici, oli e grassi animali, vegetali, minerali e siliconi, acqua, gas, glicol, molti acidi diluiti, basi e soluzioni saline. Static and dynamic sealing of aliphatic hydrocarbons, oil and grease of animal, vegetable and mineral origin, silicones, water, gas, glycol, many diluted acids, saline bases and solutions.
		70±5	140	140	100°C-70h=8,7	-25 +100	
		80±5	160	160	100°C-70h=9	-25 +100	
		90±5	180	180	100°C-70h=10	-25 +100	
EPDM	Terpolimero Etilenpropilenediene (Dutral)	60±5 70±5	150	130	100°C-70h=40	-40+110 -40+110	Per tenute statiche e dinamiche in presenza acqua calda e vapore fino a 130°C. Buona resistenza alle soluzioni acide e basiche, all'invecchiamento e agli agenti atmosferici. Static and dynamic sealing of hot water and steam up to 130°C. Good resistance to acid and basic solutions, ageing and weathering.
CR	Policloroprene (Neoprene)	60±5 70±5	115 115	285 205	100°C-70h=30 100°C-70h=30	-30+110 -30+110	Per tenute statiche e dinamiche in presenza Freon 12, fluidi refrigeranti, acqua marina, ottima resistenza all'ozono, all'invecchiamento e agli agenti atmosferici. Static and dynamic sealing of Freon 12, coolants, seawater; excellent resistance to ozone, ageing and weathering.
SI	Gomma Siliconica	50±5 60±5 70±5 80±5	60 60 64 64	400 320 210 125	150°C-24h=10 150°C-24h=11 150°C-24h=12 150°C-24h=15	-40+200 -40+200 -40+200 -40+200	Per tenute normalmente statiche con ottimo comportamento fino alle temperature estreme in presenza di aria calda e ozono, soluzioni acide, alcaline, fluidi dielettrici, compatibilità con gli alimenti. Normally static sealing (with excellent behaviour up to very high temperatures) of hot air and ozone, acid solutions, alkaline solutions and dielectric fluids; food-safe material.
FP FKM FPM	Polimero Fluorurato (Viton)	70±5 80±5	130 115	150 120	200°C-70h=20 200°C-22h=15	-10+200	Per tenute statiche e dinamiche in presenza idrocarburi alifatici e aromatici, (esclusi i chetoni); lubrificanti, oli, solventi, acidi. Ottimo comportamento alle alte temperature. Static and dynamic sealing of aliphatic and aromatic hydrocarbons (except ketons), lubricants, oil, solvents and acids. Excellent behaviour at high temperature.
EPDM epossidico	Terpolimero Etilenpropilenediene (Dutral)	70±5	110	190	150°C-24h=15 150°C-70h=25	-40+150	A differenza dell'EPDM standard resiste fino a temperatura di 160°C, migliore Compression Set, compatibilità con gli alimenti. Unlike standard EPDM, resists up to 160°C and has better compression set performance; food-safe material.
HNBR	Nitrilica Idrogenata	70±5	135	135	150°C-24h=20 150°C-70h=25	-40+150	Buona resistenza agli oli minerali, idrocarburi, acqua, vapore, gas, oli vegetali, eccezionale resistenza all'abrasione, buon comportamento all'invecchiamento. Good resistance to mineral oils, hydrocarbons, water, steam, gas and vegetable oils; exceptionally abrasion-resistant, good ageing performance.

TABELLA CALCOLO SEDI O-RINGS O-RINGS SEAT DESIGN CHART

TENUTE STATICHE STATIC SEALING

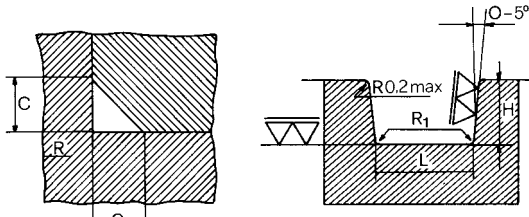

Ø Corda mm	H mm	L mm	R mm	C mm
1,00	0,80	1,30	0,20	1,40
1,50	1,20	1,95	0,20	2,00
1,78	1,30	2,40	0,20	2,40
2,00	1,60	2,60	0,20	2,70
2,50	2,00	3,25	0,20	3,40
2,62	2,10	3,40	0,20	3,60
3,00	2,40	3,90	0,30	4,00
3,53	2,80	4,55	0,40	4,80
4,00	3,20	5,20	0,40	5,40
5,00	4,00	6,50	0,50	6,70
5,34	4,30	6,85	0,50	7,20
6,00	4,80	7,80	0,60	8,00
6,99	5,60	9,80	0,60	9,40
8,00	6,40	10,40	0,60	10,70
9,00	7,20	11,70	0,60	12,00
10,00	8,00	13,00	0,60	13,40

TENUTE DINAMICHE DYNAMIC SEALING

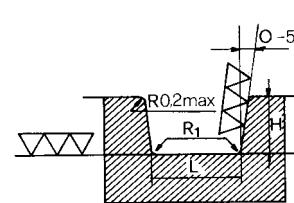

Ø Corda mm	H mm	L mm	R mm
1,00	0,90	1,30	0,20
1,50	1,35	1,95	0,20
1,78	1,65	2,35	0,20
2,00	1,80	2,60	0,20
2,50	2,25	3,25	0,20
2,62	2,35	3,40	0,20
3,00	2,70	3,90	0,30
3,53	3,15	4,55	0,40
4,00	3,60	5,20	0,40
5,00	4,50	6,50	0,50
5,34	4,80	6,95	0,50
6,00	5,40	7,80	0,60
6,99	6,30	9,10	0,60
8,00	6,30	9,10	0,60
9,00	8,10	11,70	0,60
10,00	9,00	13,00	0,60

NOTE NOTES

Possiamo fornire anelli OR in varie mescole tra le quali:

- NBR IN DUREZZA 50-60-80-90° Sh - NEOPRENE DUREZZA 70° Sh
- NBR ALIMENTARE 70° Sh - VITON IN DUREZZE 60-80-90° Sh
- NBR RESISTENTE A -40°C 70° Sh - SILICONE IN DUREZZE 50-60-70° Sh
- NBR RESISTENTE A BENZINA 70° Sh - HNBR 70° Sh
- EPDM 70° Sh - EPDM PEROX 70° Sh

We are able to supply O-Rings in different compounds:

- NBR WITH 50-60-80-90° Sh HARDNESS - NEOPRENE WITH 70° Sh HARDNESS
- FOOD-SAFE NBR WITH 70° Sh HARDNESS -FKM WITH 60-80-90° Sh HARDNESS
- -40°C RESISTANT NBR WITH 70° Sh HARDNESS SILICONE WITH 50-60-70° Sh HARDNESS
- PETROL-RESISTANT NBR WITH 70° Sh HARDNESS - HNBR WITH 70° Sh HARDNESS
- EPDM WITH 70° Sh HARDNESS - EPDM PEROX WITH 70° Sh HARDNESS

O-RINGS NBR 70sh
NBR O-RINGS 70sh



Codice Code	GB Standard		USA Standard	Ø Interno Inner Ø	Ø Corda Cord Ø	Confezione Package	Prezzo Unit Price
M751802007004	2007		2-004	1,78	1,78	3000	€ 0,0141
M751802010004	2010		2-005	2,57	1,78	3000	€ 0,0141
M751802012004	2012	101	2-006	2,90	1,78	3000	€ 0,0141
M751802015004	2015	102	2-007	3,69	1,78	3000	€ 0,0143
M751802018004	2018	103	2-008	4,48	1,78	3000	€ 0,0149
M751802021004	2021	104	2-009	5,28	1,78	3000	€ 0,0166
M751802025004	2025	105	2-010	6,07	1,78	3000	€ 0,0171
M751802028004		106	5-052	6,75	1,78	3000	€ 0,0177
M751802031004	2031	107	2-011	7,66	1,78	3000	€ 0,0185
M751802033004	2033	108	5-612	8,73	1,78	3000	€ 0,0194
M751802037004	2037	110	2-012	9,25	1,78	3000	€ 0,0199
M751802043004	2043		2-013	10,82	1,78	3000	€ 0,0211
M751802046004		114	5-613	11,11	1,78	2000	€ 0,0216
M751802050004	2050		2-014	12,42	1,78	2000	€ 0,0222
M751802056004	2056		2-015	14,00	1,78	2000	€ 0,0236
M751802062004	2062		2-016	15,60	1,78	2000	€ 0,0259
M751802068004	2068		2-017	17,17	1,78	1000	€ 0,0281
M751802075004	2075		2-018	18,77	1,78	1000	€ 0,0295
M751802081004	2081		2-019	20,35	1,78	1000	€ 0,0332
M751802087004	2087		2-020	21,95	1,78	1000	€ 0,0360
M751802093004	2093		2-021	23,52	1,78	1000	€ 0,0405
M751802100004	2100		2-022	25,12	1,78	1000	€ 0,0450
M751802106004	2106		2-023	26,70	1,78	1000	€ 0,0501
M751802112004	2112		2-024	28,30	1,78	1000	€ 0,0551
M751802118004	2118		2-025	29,87	1,78	1000	€ 0,0585
M751802125004	2125		2-026	31,47	1,78	1000	€ 0,0633
M751802131004	2131		2-027	33,05	1,78	500	€ 0,0675
M751802137004	2137		2-028	34,65	1,78	500	€ 0,0721
M751802150004	2150		2-029	37,82	1,78	500	€ 0,0861
M751802162004	2162		2-030	41,00	1,78	500	€ 0,0968
M751802175004	2175		2-031	44,17	1,78	500	€ 0,1013
M751802187004	2187		2-032	47,37	1,78	500	€ 0,1064
M751802200004	2200		2-033	50,52	1,78	500	€ 0,1115
M751802212004	2212		2-034	53,67	1,78	500	€ 0,1168
M751802225004	2225		2-035	56,87	1,78	500	€ 0,1239
M751802237004	2237		2-036	60,04	1,78	500	€ 0,1303
M751802250004	2250		2-037	63,22	1,78	500	€ 0,1379
M751802262004	2262		2-038	66,40	1,78	500	€ 0,1455
M751802275004	2275		2-039	69,57	1,78	500	€ 0,1532
M751802287004	2287		2-040	72,76	1,78	250	€ 0,1675

O-RINGS NBR 70sh
NBR O-RINGS 70sh



Codice Code	GB Standard		USA Standard	Ø Interno Inner Ø	Ø Corda Cord Ø	Confezione Package	Prezzo Unit Price
M751802300004	2300		2-041	75,94	1,78	250	€ 0,1830
M751802312004	2312			79,00	1,78	250	€ 0,1993
M751802325004	2325		2-042	82,28	1,78	250	€ 0,2083
M751802350004	2350		2-043	88,64	1,78	250	€ 0,2336
M751802362004	2362			91,70	1,78	250	€ 0,2441
M751802375004	2375		2-044	95,00	1,78	250	€ 0,2534
M751802387004	2387			98,05	1,78	250	€ 0,2632
M751802400004	2400		2-045	101,34	1,78	250	€ 0,2716
M751802412004	2412			104,40	1,78	250	€ 0,2815
M751802425004	2425		2-046	107,70	1,78	250	€ 0,2956
M751802450004	2450		2-047	114,00	1,78	250	€ 0,3129
M751802462004	2462			117,10	1,78	100	€ 0,3153
M751802475004	2475		2-048	120,37	1,78	100	€ 0,3266
M751802500004	2500		2-049	126,72	1,78	100	€ 0,3497
M751802525004	2525		2-050	133,10	1,78	100	€ 0,3604
M751802562004	2562			142,11	1,78	100	€ 0,3998
M751802637004	2637			161,16	1,78	100	€ 0,4814
M751802652004	2652			164,34	1,78	100	€ 0,4926
M752602840004				2,84	2,62	3000	€ 0,0171
M752603630004				3,63	2,62	3000	€ 0,0180
M752603018004	3018			4,42	2,62	3000	€ 0,0188
M752603021004	3021			5,23	2,62	3000	€ 0,0197
M752603024004	3024			6,02	2,62	3000	€ 0,0219
M752603030004	3030			7,60	2,62	3000	€ 0,0236
M752603036004	3036	109	2-110	9,13	2,62	3000	€ 0,0245
M752603037004	3037	111	2-110	9,19	2,62	3000	€ 0,0245
M752603039004		112	5-614	9,92	2,62	3000	€ 0,0259
M752603043004	3043	113	2-111	10,78	2,62	2000	€ 0,0281
M752603047004	3047	115	5-615	11,91	2,62	2000	€ 0,0298
M752603050004	3050	116	2-112	12,37	2,62	2000	€ 0,0306
M752603053004	3053	117	5-616	13,10	2,62	2000	€ 0,0312
M752603056004	3056	118	2-113	13,95	2,62	2000	€ 0,0327
M752603060004		119	5-243	15,08	2,62	2000	€ 0,0351
M752603062004	3062	120	2-114	15,54	2,62	1000	€ 0,0355
M752603064004		121	5-617	15,88	2,62	1000	€ 0,0360
M752603068004	3068	122	2-115	17,13	2,62	1000	€ 0,0377
M752603070004		123	5-256	17,86	2,62	1000	€ 0,0383
M752603075004	3075	124	2-116	18,72	2,62	1000	€ 0,0391
M752603081004	3081	127	2-117	20,24	2,62	1000	€ 0,0442
M752603083004		128	2-117	20,63	2,62	1000	€ 0,0450

O-RINGS NBR 70sh
NBR O-RINGS 70sh



Codice Code	GB Standard	USA Standard	Ø Interno Inner Ø	Ø Corda Cord Ø	Confezione Package	Prezzo Unit Price	
M752603087004	3087		2-118	22,00	2,62	1000	€ 0,0478
M752603089004		130	2-118	22,22	2,62	1000	€ 0,0490
M752603093004	3093		2-119	23,47	2,62	1000	€ 0,0518
M752603095004		132	2-119	23,81	2,62	1000	€ 0,0540
M752603100004	3100		2-120	25,07	2,62	1000	€ 0,0591
M752603106004	3106		2-121	26,65	2,62	1000	€ 0,0625
M752603112004	3112		2-122	28,25	2,62	1000	€ 0,0664
M752603118004	3118		2-123	29,82	2,62	1000	€ 0,0715
M752603125004	3125		2-124	31,42	2,62	500	€ 0,0760
M752603131004	3131		2-125	32,99	2,62	500	€ 0,0782
M752603137004	3137		2-126	34,60	2,62	500	€ 0,0810
M752603143004	3143		2-127	36,17	2,62	500	€ 0,0861
M752603150004	3150		2-128	37,77	2,62	500	€ 0,0923
M752603156004	3156		2-129	39,34	2,62	500	€ 0,0968
M752603162004	3162		2-130	40,95	2,62	500	€ 0,1041
M752603168004	3168		2-131	42,52	2,62	500	€ 0,1126
M752603175004	3175		2-132	44,12	2,62	500	€ 0,1199
M752603181004	3181		2-133	45,69	2,62	500	€ 0,1261
M752603187004	3187		2-134	47,30	2,62	500	€ 0,1295
M752603193004	3193		2-135	48,89	2,62	500	€ 0,1340
M752603200004	3200		2-136	50,47	2,62	500	€ 0,1362
M752603206004	3206		2-137	52,07	2,62	500	€ 0,1362
M752603212004	3212		2-138	53,65	2,62	250	€ 0,1390
M752603218004	3218		2-139	55,25	2,62	250	€ 0,1436
M752603225004	3225		2-140	56,82	2,62	250	€ 0,1478
M752603231004	3231		2-141	58,42	2,62	250	€ 0,1520
M752603237004	3237		2-142	60,00	2,62	250	€ 0,1576
M752603243004	3243		2-143	61,60	2,62	250	€ 0,1633
M752603250004	3250		2-144	63,17	2,62	250	€ 0,1661
M752603256004	3256		2-145	64,77	2,62	250	€ 0,1689
M752603262004	3262		2-146	66,35	2,62	250	€ 0,1717
M752603268004	3268		2-147	67,95	2,62	250	€ 0,1745
M752632750004	3275		2-148	69,52	2,62	250	€ 0,1830
M752603281004	3281		2-149	71,12	2,62	250	€ 0,1886
M752603287004	3287		2-150	72,70	2,62	250	€ 0,1970
M752603300004	3300		2-151	75,88	2,62	250	€ 0,2140
M752603325004	3325		2-152	82,22	2,62	250	€ 0,2421
M752603350004	3350		2-153	88,58	2,62	250	€ 0,2646
M752603375004	3375		2-154	94,93	2,62	150	€ 0,2787
M752603400004	3400		2-155	101,28	2,62	150	€ 0,2928

O-RINGS NBR 70sh
NBR O-RINGS 70sh



Codice Code	GB Standard		USA Standard	Ø Interno Inner Ø	Ø Corda Cord Ø	Confezione Package	Prezzo Unit Price
M752603425004	3425		2-156	107,63	2,62	150	€ 0,3068
M752603450004	3450		2-157	113,98	2,62	150	€ 0,3378
M752603475004	3475		2-158	120,33	2,62	150	€ 0,3744
M752603500004	3500		2-159	126,67	2,62	150	€ 0,4110
M752603525004	3525		2-160	133,00	2,62	100	€ 0,4448
M752603550004	3550		2-161	139,38	2,62	100	€ 0,4786
M752603575004	3575		2-162	145,72	2,62	100	€ 0,5208
M752603600004	3600		2-163	152,07	2,62	100	€ 0,5405
M752603625004	3625		2-164	158,42	2,62	100	€ 0,5574
M752616477004	3650		2-165	164,77	2,62	100	€ 0,5771
M752603675004	3675		2-166	171,13	2,62	100	€ 0,5912
M752603700004	3700		2-167	177,47	2,62	100	€ 0,6053
M752603725004	3725		2-168	183,83	2,62	100	€ 0,6194
M752603750004	3750		2-169	190,18	2,62	100	€ 0,6475
M752603775004	3775		2-170	196,53	2,62	100	€ 0,6757
M752603800005	3800		2-171	202,88	2,62	100	€ 0,7038
M752603825004	3825		2-172	209,22	2,62	100	€ 0,9009
M752603850004	3850		2-173	215,58	2,62	100	€ 0,9009
M752603875004	3875		2-174	221,92	2,62	100	€ 0,9572
M752601750004	3900		2-175	228,27	2,62	100	€ 1,0135
M752603925004	3925		2-176	234,62	2,62	100	€ 1,0698
M752603950004	3950		2-177	240,97	2,62	100	€ 1,5766
M752603975004	3975		2-178	247,32	2,62	100	€ 1,6329
M753504340004				4,34	3,53	2000	€ 0,0281
M753505940004				5,94	3,53	2000	€ 0,0295
M753504028004	4028		2-203	7,52	3,53	2000	€ 0,0318
M753504036004	4036		2-204	9,12	3,53	2000	€ 0,0337
M753501069004			2-205	10,69	3,53	2000	€ 0,0365
M753501227004	4050		2-206	12,29	3,53	2000	€ 0,0394
M753504055004	4055		2-207	13,87	3,53	2000	€ 0,0436
M753501547004	4061		2-208	15,47	3,53	1000	€ 0,0470
M753501704004	4067		2-209	17,04	3,53	1000	€ 0,0492
M753504075004	4075	125	2-210	18,64	3,53	1000	€ 0,0532
M753504081004	4081	126	2-211	20,22	3,53	1000	€ 0,0568
M753504087004	4087	129	2-212	21,82	3,53	1000	€ 0,0602
M753504093004	4093	131	2-213	23,40	3,53	1000	€ 0,0642
M753504100004	4100	133	2-214	24,99	3,53	1000	€ 0,0693
M753504103004		134	5-618	25,80	3,53	1000	€ 0,0743
M753504106004	4106	135	2-215	26,57	3,53	1000	€ 0,0788
M753504112004	4112	136	2-216	28,17	3,53	500	€ 0,0816

O-RINGS NBR 70sh
NBR O-RINGS 70sh



Codice Code	GB Standard		USA Standard	Ø Interno Inner Ø	Ø Corda Cord Ø	Confezione Package	Prezzo Unit Price
M753504118004	4118	137	2-217	29,75	3,53	500	€ 0,0844
M753504125004	4125	138	2-218	31,34	3,53	500	€ 0,0912
M753504131004	4131	139	2-219	32,93	3,53	500	€ 0,0968
M753504137004	4137	140	2-220	34,52	3,53	500	€ 0,0991
M753504143004	4143	141	2-221	36,10	3,53	500	€ 0,1013
M753504150004	4150	142	2-222	37,69	3,53	500	€ 0,1053
M753504156004		144	5-321	39,69	3,53	500	€ 0,1103
M753504162004	4162		2-223	40,87	3,53	500	€ 0,1148
M753504166004		146	2-223	41,28	3,53	500	€ 0,1204
M753504170004		147	5-332	42,86	3,53	500	€ 0,1255
M753504175504	4175		2-224	44,04	3,53	500	€ 0,1306
M753504178004		149	2-224	44,45	3,53	500	€ 0,1351
M753504183004		150	5-035	46,04	3,53	500	€ 0,1407
M753541870004	4187		2-225	47,23	3,53	500	€ 0,1464
M753504190004		152	2-225	47,62	3,53	500	€ 0,1492
M753504193004		153	5-701	49,21	3,53	500	€ 0,1520
M753542000004	4200		2-226	50,40	3,53	250	€ 0,1554
M753504202004		155	2-226	50,80	3,53	250	€ 0,1576
M753504208004		156	5-037	52,39	3,53	250	€ 0,1610
M753504212004	4212		2-227	53,57	3,53	250	€ 0,1649
M753504214004		158	2-227	53,97	3,53	250	€ 0,1677
M753504220004		159		55,56	3,53	250	€ 0,1717
M753505674004	4225		2-228	56,75	3,53	250	€ 0,1751
M753504228004		161	2-228	57,15	3,53	250	€ 0,1790
M753504233004		162	5-702	58,74	3,53	250	€ 0,1830
M753504237004	4237		2-229	59,92	3,53	250	€ 0,1863
M753504240004		164	2-229	60,32	3,53	250	€ 0,1886
M753504245004		165		61,91	3,53	250	€ 0,1914
M753504250004	4250		2-230	63,10	3,53	250	€ 0,1942
M753504252004		167	2-230	63,50	3,53	250	€ 0,1999
M753504258004		168	5-703	65,10	3,53	250	€ 0,2083
M753504262004	4262		2-231	66,27	3,53	250	€ 0,2140
M753504264004		170	2-231	66,68	3,53	250	€ 0,2168
M753504270004		171	5-361	68,26	3,53	250	€ 0,2207
M753504275004	4275		2-232	69,44	3,53	250	€ 0,2252
M753504278004		173	2-232	69,85	3,53	250	€ 0,2308
M753504282004		174	5-704	71,44	3,53	250	€ 0,2421
M753504287004	4287		2-233	72,62	3,53	250	€ 0,2494
M753504290004		176	2-233	73,02	3,53	250	€ 0,2534
M753501770004		177	5-705	74,61	3,53	250	€ 0,2579

O-RINGS NBR 70sh
NBR O-RINGS 70sh



Codice Code	GB Standard	USA Standard	Ø Interno Inner Ø	Ø Corda Cord Ø	Confezione Package	Prezzo Unit Price
M753504300004	4300	2-234	75,80	3,53	250	€ 0,2624
M753504312004	4312	2-235	78,97	3,53	250	€ 0,2702
M753504325004	4325	2-236	82,14	3,53	250	€ 0,2815
M753504337004	4337	2-237	85,32	3,53	250	€ 0,2928
M753504350004	4350	2-238	88,50	3,53	250	€ 0,3012
M753504362004	4362	2-239	91,67	3,53	250	€ 0,3097
M753504375004	4375	2-240	94,84	3,53	250	€ 0,3209
M753504387004	4387	2-241	98,02	3,53	150	€ 0,3322
M753504400004	4400	2-242	101,20	3,53	150	€ 0,3434
M753504412004	4412	2-243	104,40	3,53	150	€ 0,3519
M753504425004	4425	2-244	107,50	3,53	150	€ 0,3604
M753504437004	4437	2-245	110,72	3,53	150	€ 0,3716
M753504450004	4450	2-246	113,90	3,53	150	€ 0,3829
M753504462004	4462	2-247	117,10	3,53	150	€ 0,3941
M753504475004	4475	2-248	120,24	3,53	150	€ 0,4054
M753504487004	4487	2-249	123,40	3,53	150	€ 0,4166
M753504500004	4500	2-250	126,60	3,53	150	€ 0,4504
M753502510004	4512	2-251	129,80	3,53	100	€ 0,4842
M753504525004	4525	2-252	132,94	3,53	100	€ 0,5011
M753504537004	4537	2-253	136,12	3,53	100	€ 0,5180
M753501390004	4550	2-254	139,30	3,53	100	€ 0,5292
M753504562004	4562	2-255	142,50	3,53	100	€ 0,5405
M753504575004	4575	2-256	145,60	3,53	100	€ 0,5518
M753545870004	4587	2-257	148,82	3,53	100	€ 0,5630
M753504600004	4600	2-258	152,00	3,53	100	€ 0,5968
M753504625004	4625	2-259	158,35	3,53	100	€ 0,6306
M753504650004	4650	2-260	164,70	3,53	50	€ 0,6475
M753504675004	4675	2-261	171,05	3,53	50	€ 0,6644
M753504700004	4700	2-262	177,40	3,53	50	€ 0,6869
M753504725004	4725	2-263	183,75	3,53	50	€ 0,7094
M753504750004	4750	2-264	190,10	3,53	50	€ 0,7320
M753547750004	4775	2-265	196,45	3,53	50	€ 0,7545
M753548000004	4800	2-266	202,80	3,53	50	€ 0,8165
M753504825004	4825	2-267	209,15	3,53	50	€ 0,9291
M753504850004	4850	2-268	215,50	3,53	50	€ 0,9853
M753502690004	4875	2-269	221,85	3,53	50	€ 1,2669
M753504900004	4900	2-270	228,20	3,53	50	€ 1,4076
M753504925004	4925	2-271	234,55	3,53	50	€ 1,5484
M753504950004	4950	2-272	240,90	3,53	50	€ 1,6892
M753504975004	4975	2-273	247,20	3,53	50	€ 1,7174

O-RINGS NBR 70sh
NBR O-RINGS 70sh



Codice Code	GB Standard		USA Standard	Ø Interno Inner Ø	Ø Corda Cord Ø	Confezione Package	Prezzo Unit Price
M753541000004	41000		2-274	253,60	3,53	50	€ 1,7455
M753541050004	41050		2-275	266,30	3,53	30	€ 1,7962
M753541100004	41100		2-276	279,00	3,53	30	€ 1,8863
M753541150004	41150		2-277	291,70	3,53	30	€ 1,9707
M753541200004	41200		2-278	304,39	3,53	30	€ 2,0833
M753541300004	41300		2-279	329,80	3,53	30	€ 2,1959
M753541400004	41400		2-280	355,20	3,53	30	€ 2,3930
M753541500004	41500		2-281	380,60	3,53	20	€ 2,5901
M753541600004	41600		2-282	405,26	3,53	20	€ 2,8153
M753541700004	41700		2-283	430,66	3,53	20	€ 3,0969
M753541800004	41800		2-284	456,06	3,53	20	€ 3,6600
M755301207004				12,07	5,34	500	€ 0,0929
M755301364004				13,64	5,34	500	€ 0,0985
M755301524004				15,24	5,34	500	€ 0,1013
M755301680004				16,81	5,34	500	€ 0,1084
M755301842004				18,42	5,34	500	€ 0,1140
M755301999004				19,99	5,34	500	€ 0,1210
M755302159004				21,59	5,34	500	€ 0,1323
M755302316004				23,16	5,34	500	€ 0,1407
M755302477004				24,77	5,34	500	€ 0,1407
M755302634004				26,34	5,34	500	€ 0,1492
M755302794004				27,94	5,34	500	€ 0,1520
M755302952004				29,51	5,34	500	€ 0,1576
M755303112004				31,12	5,34	250	€ 0,1661
M755303269004				32,69	5,34	250	€ 0,1731
M755300324004				34,29	5,34	250	€ 0,1788
M755303747004	6150	143	2-325	37,47	5,34	250	€ 0,1852
M755306162004	6162	145	2-326	40,65	5,34	250	€ 0,1934
M755306175004	6175	148	2-327	43,82	5,34	250	€ 0,2038
M755306187004	6187	151	2-328	47,00	5,34	250	€ 0,2117
M755306200004	6200	154	2-329	50,16	5,34	250	€ 0,2277
M755306212004	6212	157	2-330	53,34	5,34	250	€ 0,2381
M755306225004	6225	160	2-331	56,52	5,34	250	€ 0,2674
M755306237004	6237	163	2-332	59,69	5,34	150	€ 0,2815
M755306250004	6250	166	2-333	62,87	5,34	150	€ 0,2956
M755306262004	6262	169	2-334	66,04	5,34	150	€ 0,3097
M755306275004	6275	172	2-335	69,22	5,34	150	€ 0,3238
M755306287004	6287	175	2-336	72,39	5,34	150	€ 0,3632
M755306293004		178		74,63	5,34	150	€ 0,3716

O-RINGS NBR 70sh
NBR O-RINGS 70sh



Codice Code	GB Standard		USA Standard	Ø Interno Inner Ø	Ø Corda Cord Ø	Confezione Package	Prezzo Unit Price
M755306300004	6300	179	2-337	75,57	5,34	150	€ 0,3800
M755306312004	6312	180	2-338	78,74	5,34	150	€ 0,3857
M755301810004		181		79,77	5,34	150	€ 0,3998
M755306325004	6325	182	2-339	81,92	5,34	150	€ 0,4223
M755306337004	6337	183	2-340	85,10	5,34	150	€ 0,4336
M755306350004	6350	184	2-341	88,27	5,34	150	€ 0,4448
M755389690004		185		89,69	5,34	150	€ 0,4532
M755306362004	6362	186	2-342	91,44	5,34	150	€ 0,4645
M755306375004	6375	187	2-343	94,62	5,34	100	€ 0,4814
M755306387004	6387	188	2-344	97,79	5,34	100	€ 0,4898
M755306395004		189		100,00	5,34	100	€ 0,4926
M755306400004	6400	190	2-345	101,00	5,34	100	€ 0,4955
M755301041004	6412	191	2-346	104,10	5,34	100	€ 0,5068
M755306425004	6425	192	2-347	107,32	5,34	100	€ 0,5180
M755306432004		193		109,50	5,34	100	€ 0,5292
M755306437005	6437	194	2-348	110,50	5,34	100	€ 0,5377
M755306450004	6450	195	2-349	113,70	5,34	100	€ 0,5687
M753501175004		199		117,48	5,34	100	€ 0,5856
M755306470004		201		120,70	5,34	100	€ 0,5968
M755306480004		203		123,83	5,34	100	€ 0,6475
M755306490004		206		127,00	5,34	100	€ 0,6757
M755306500004		208		130,20	5,34	100	€ 0,6982
M755306510004		210		133,35	5,34	100	€ 0,7151
M755301360004		213		136,53	5,34	100	€ 0,7320
M755306530004		215		139,70	5,34	100	€ 0,7489
M755306540004		217		142,90	5,34	100	€ 0,7629
M755306550004		219		146,10	5,34	100	€ 0,7883
M755306570004		221		149,23	5,34	100	€ 0,8221
M757008450004	8450	196	2-425	113,70	6,99	100	€ 0,7376
M757008455004		197		114,70	6,99	100	€ 0,7545
M757008462004	8462	198	2-426	116,84	6,99	100	€ 0,7742
M757008475004	8475	200	2-427	120,00	6,99	100	€ 0,8080
M757008487004	8487	202	2-428	123,20	6,99	50	€ 0,8474
M757008490004		204		124,60	6,99	50	€ 0,8643
M757008500004	8500	205	2-429	126,37	6,99	50	€ 0,8784
M757085120004	8512	207	2-430	129,50	6,99	50	€ 0,9009
M757008525004	8525	209	2-431	132,72	6,99	50	€ 0,9459
M757008530004		211		134,50	6,99	50	€ 0,9572
M757008537004	8537	212	2-432	135,90	6,99	50	€ 0,9685

O-RINGS NBR 70sh
NBR O-RINGS 70sh



Codice Code	GB Standard		USA Standard	Ø Interno Inner Ø	Ø Corda Cord Ø	Confezione Package	Prezzo Unit Price
M757008550004	8550	214	2-433	139,07	6,99	50	€ 1,0135
M757008562004	8562	216	2-434	142,24	6,99	50	€ 1,0529
M757008575004	8575	218	2-435	145,42	6,99	50	€ 1,0811
M757008587004	8587	220	2-436	148,60	6,99	50	€ 1,1036
M757008600004	8600	222	2-437	151,77	6,99	50	€ 1,1261
M757008610004		223		155,60	6,99	50	€ 1,1374
M757008625004	8625	224	2-438	158,10	6,99	50	€ 1,1487
M757008630004		225		159,50	6,99	50	€ 1,1543
M757008640004		226		161,90	6,99	50	€ 1,1599
M757008650004	8650	227	2-439	164,47	6,99	50	€ 1,1655
M757008655004		228		166,70	6,99	50	€ 1,1768
M757008665004		229		168,30	6,99	50	€ 1,1824
M757008675004	8675	230	2-440	170,82	6,99	50	€ 1,1881
M757008685004		231		174,60	6,99	50	€ 1,2049
M757008700004	8700	232	2-441	177,17	6,99	50	€ 1,2162
M757008715004		233		181,00	6,99	30	€ 1,2331
M757008725004	8725	234	2-442	183,52	6,99	30	€ 1,2444
M757008740004		235		187,30	6,99	30	€ 1,2669
M757008750004	8750	236	2-443	189,90	6,99	30	€ 1,2950
M757008760004		237		193,70	6,99	30	€ 1,3232
M757008775004	8775	238	2-444	196,22	6,99	30	€ 1,3514
M757008785004	8785	239		200,00	6,99	30	€ 1,4076
M757008800004	8800	240	2-445	202,57	6,99	30	€ 1,6047
M757008825004	8825	241		208,92	6,99	30	€ 1,6892
M757008850004	8850	242	2-446	215,27	6,99	30	€ 1,7736
M757008875004	8875	243		221,62	6,99	30	€ 2,1312
M757008900004	8900	244	2-447	227,90	6,99	30	€ 2,2382
M757008925004	8925	245		234,30	6,99	30	€ 2,4043
M757008950004	8950	246	2-448	240,70	6,99	30	€ 2,4409
M757008975004	8975	247		247,00	6,99	30	€ 2,4803
M757081000004	81000	248	2-449	253,57	6,99	30	€ 2,5113
M757081025004	81025	249		259,70	6,99	30	€ 2,5676
M757081050004	81050	250	2-450	266,10	6,99	30	€ 2,6211
M757081075004	81075	251		272,40	6,99	30	€ 2,6774
M757081100004	81100	252	2-451	278,77	6,99	30	€ 2,7309
M757081125004	81125	253		285,10	6,99	30	€ 2,8238
M757081150004	81150	254	2-452	291,50	6,99	30	€ 2,9392
M757081175004	81175	255		297,80	6,99	30	€ 3,0575

O-RINGS NBR 70sh
NBR O-RINGS 70sh



Codice Code	GB Standard		USA Standard	Ø Interno Inner Ø	Ø Corda Cord Ø	Confezione Package	Prezzo Unit Price
M757081200004	81200	256	2-453	304,17	6,99	30	€ 3,1785
M757081250004	81250	257	2-454	316,87	6,99	20	€ 3,2996
M757081300004	81300	258	2-455	329,50	6,99	20	€ 3,4403
M757081350004	81350	259	2-456	342,27	6,99	20	€ 3,6149
M756981400004	81400	260	2-457	354,97	6,99	20	€ 3,7894
M757081450004	81450	261	2-458	367,67	6,99	20	€ 3,9696
M757081500004	81500	262	2-459	380,30	6,99	20	€ 4,0963
M757081550004	81550	263	2-460	393,10	6,99	20	€ 4,2061
M751600220004	R 00			2,20	1,60	3000	€ 0,0141
M751900240004	R 0			2,40	1,90	3000	€ 0,0141
M751900260004	R 1			2,60	1,90	3000	€ 0,0141
M751900340004	R 2			3,40	1,90	3000	€ 0,0141
M751900420004	R 3			4,20	1,90	3000	€ 0,0143
M751900490004	R 4			4,90	1,90	3000	€ 0,0139
M751900570004	R 5			5,70	1,90	3000	€ 0,0152
M751900640004	R 5A			6,40	1,90	3000	€ 0,0160
M751900720004	R 6			7,20	1,90	3000	€ 0,0169
M751900800004	R 6A			8,00	1,90	3000	€ 0,0177
M751900890004	R 7			8,90	1,90	3000	€ 0,0183
M752700890004	R 8			8,90	2,70	3000	€ 0,0259
M752700105004	R 9			10,50	2,70	3000	€ 0,0298
M75270121004	R 10			12,10	2,70	3000	€ 0,0327
M752701360004	R 11			13,60	2,70	3000	€ 0,0337
M752701510004	R 12			15,10	2,70	3000	€ 0,0371
M752701690004	R 13			16,90	2,70	3000	€ 0,0411
M752701840004	R 14			18,40	2,70	3000	€ 0,0422
M753601830004	R 15			18,30	3,60	1500	€ 0,0580
M753601980004	R 16			19,80	3,60	1500	€ 0,0630
M753602130004	R 17			21,30	3,60	1500	€ 0,0693
M753602300004	R 18			23,00	3,60	1500	€ 0,0754
M753602460004	R 19			24,60	3,60	1500	€ 0,0794
M753602620004	R 20			26,20	3,60	1500	€ 0,0804
M753602780004	R 21			27,80	3,60	1500	€ 0,0884
M753602930004	R 22			29,30	3,60	1500	€ 0,0946
M753603080004	R 23			30,80	3,60	500	€ 0,0985
M753603250004	R 24			32,50	3,60	500	€ 0,1030
M753603410004	R 25			34,10	3,60	500	€ 0,1081
M753603560004	R 26			35,60	3,60	500	€ 0,1131
M753603730004	R 27			37,30	3,60	500	€ 0,1182

O-RINGS METRICI NBR 70sh
O-RINGS METRIC STANDARDS NBR 70sh



Codice Code	Ø Interno Inner Ø	Ø Corda Cord Ø	Lotto Minimo Min. Quantity	Prezzo Unit Price
M751000200004	2	1	3000	€ 0,0217
M751000300004	3	1	3000	€ 0,0217
M751000400004	4	1	3000	€ 0,0230
M751000500004	5	1	3000	€ 0,0236
M751000600004	6	1	3000	€ 0,0247
M751000700004	7	1	3000	€ 0,0254
M751000800004	8	1	3000	€ 0,0272
M751000900004	9	1	3000	€ 0,0278
M751001000004	10	1	3000	€ 0,0284
M751001100004	11	1	2000	€ 0,0290
M751001200004	12	1	2000	€ 0,0296
M751001300004	13	1	2000	€ 0,0302
M751001400004	14	1	2000	€ 0,0320
M751001500004	15	1	2000	€ 0,0338
M751001600004	16	1	2000	€ 0,0356
M751001700004	17	1	1000	€ 0,0362
M751001800004	18	1	1000	€ 0,0398
M751002000004	20	1	1000	€ 0,0483
M751500200004	2	1,5	3000	€ 0,0211
M751500300004	3	1,5	3000	€ 0,0211
M751500400004	4	1,5	3000	€ 0,0230
M751500500004	5	1,5	3000	€ 0,0213
M751500600004	6	1,5	3000	€ 0,0247
M751500700004	7	1,5	3000	€ 0,0266
M751500800004	8	1,5	3000	€ 0,0278
M751500900004	9	1,5	3000	€ 0,0278
M751501000004	10	1,5	3000	€ 0,0278
M751501100004	11	1,5	2000	€ 0,0290
M751501200004	12	1,5	2000	€ 0,0296
M751501250004	12,5	1,5	2000	€ 0,0302
M751501300004	13	1,5	2000	€ 0,0308
M751501400004	14	1,5	2000	€ 0,0332
M751501500004	15	1,5	2000	€ 0,0350
M751501600004	16	1,5	2000	€ 0,0374
M751501700004	17	1,5	1000	€ 0,0393
M751501800004	18	1,5	1000	€ 0,0398
M751501900004	19	1,5	1000	€ 0,0429
M751502000004	20	1,5	1000	€ 0,0501
M751502100004	21	1,5	1000	€ 0,0525
M751502200004	22	1,5	1000	€ 0,0550



O-RINGS METRICI NBR 70sh
O-RINGS METRIC STANDARDS NBR 70sh

Codice Code	Ø Interno Inner Ø	Ø Corda Cord Ø	Lotto Minimo Min. Quantity	Prezzo Unit Price
M751502300004	23	1,5	1000	€ 0,0574
M751502400004	24	1,5	1000	€ 0,0610
M751500250004	25	1,5	1000	€ 0,0676
M751502600004	26	1,5	1000	€ 0,0706
M751502750004	27,5	1,5	1000	€ 0,0731
M751502800004	28	1,5	1000	€ 0,0736
M752000300004	3	2	3000	€ 0,0196
M752000400004	4	2	3000	€ 0,0211
M752000500004	5	2	3000	€ 0,0218
M752000600004	6	2	3000	€ 0,0230
M752000700004	7	2	3000	€ 0,0266
M752000750004	7,5	2	3000	€ 0,0272
M752000800004	8	2	3000	€ 0,0272
M752000900004	9	2	3000	€ 0,0302
M752001000004	10	2	3000	€ 0,0332
M752001100004	11	2	3000	€ 0,0350
M752001200004	12	2	2000	€ 0,0356
M752001300004	13	2	2000	€ 0,0380
M752001400004	14	2	2000	€ 0,0398
M752001500004	15	2	2000	€ 0,0429
M752001600004	16	2	2000	€ 0,0459
M752001700004	17	2	2000	€ 0,0507
M752001800004	18	2	1000	€ 0,0507
M752001900004	19	2	1000	€ 0,0543
M752002000004	20	2	1000	€ 0,0580
M752002100004	21	2	1000	€ 0,0616
M752002200004	22	2	1000	€ 0,0628
M752002400004	24	2	1000	€ 0,0712
M752002600004	26	2	1000	€ 0,0785
M752002800004	28	2	1000	€ 0,0845
M752003000004	30	2	500	€ 0,0906
M752003200004	32	2	500	€ 0,0966
M752003600004	36	2	500	€ 0,1063
M752004000004	40	2	500	€ 0,1159
M752004200004	42	2	500	€ 0,1232
M752005000004	50	2	500	€ 0,1690
M752005800004	58	2	250	€ 0,1787
M752006600004	66	2	250	€ 0,2047
M752007000004	70	2	250	€ 0,2239
M752008500004	85	2	250	€ 0,2790

O-RINGS METRICI NBR 70sh
O-RINGS METRIC STANDARDS NBR 70sh



Codice Code	Ø Interno Inner Ø	Ø Corda Cord Ø	Lotto Minimo Min. Quantity	Prezzo Unit Price
M752400330004	3,3	2,4	3000	€ 0,0230
M752400430004	4,3	2,4	3000	€ 0,0230
M752400530004	5,3	2,4	3000	€ 0,0242
M752400630004	6,3	2,4	3000	€ 0,0278
M752407300005	7,3	2,4	3000	€ 0,0284
M752400830005	8,3	2,4	3000	€ 0,0308
M752409300005	9,3	2,4	3000	€ 0,0326
M752400103004	10,3	2,4	3000	€ 0,0332
M752401130005	11,3	2,4	2000	€ 0,0344
M752401230005	12,3	2,4	2000	€ 0,0344
M752401330005	13,3	2,4	2000	€ 0,0374
M752401430005	14,3	2,4	2000	€ 0,0423
M752401530004	15,3	2,4	2000	€ 0,0423
M752401630005	16,3	2,4	1000	€ 0,0471
M752401730004	17,3	2,4	1000	€ 0,0513
M752401860004	18,6	2,4	1000	€ 0,0543
M752401960004	19,6	2,4	1000	€ 0,0561
M752402050004	20,5	2,4	1000	€ 0,0586
M752402160004	21,6	2,4	1000	€ 0,0664
M752402350004	23,5	2,4	1000	€ 0,0761
M752402500004	25	2,4	1000	€ 0,0785
M752402960004	29,6	2,4	1000	€ 0,0894
M752500500004	5	2,5	3000	€ 0,0230
M752500600004	6	2,5	3000	€ 0,0272
M752500800004	8	2,5	3000	€ 0,0308
M752500900004	9	2,5	3000	€ 0,0344
M752501000004	10	2,5	2000	€ 0,0350
M752401230004	12	2,5	2000	€ 0,0386
M752501400004	14	2,5	2000	€ 0,0417
M752501500004	15	2,5	2000	€ 0,0441
M752501600004	16	2,5	1000	€ 0,0489
M752501800004	18	2,5	1000	€ 0,0555
M752502000004	20	2,5	1000	€ 0,0592
M752502400004	24	2,5	1000	€ 0,0785
M752502500004	25	2,5	1000	€ 0,0809
M752503000004	30	2,5	1000	€ 0,1026
M752503500004	35	2,5	500	€ 0,1135
M752504000004	40	2,5	500	€ 0,1268
M753000600004	6	3	3000	€ 0,0314
M753000700004	7	3	3000	€ 0,0326
M753000900004	9	3	3000	€ 0,0398

O-RINGS METRICI NBR 70sh
O-RINGS METRIC STANDARDS NBR 70sh



Codice Code	Ø Interno Inner Ø	Ø Corda Cord Ø	Lotto Minimo Min. Quantity	Prezzo Unit Price
M753001000004	10	3	1000	€ 0,0411
M753001100004	11	3	1000	€ 0,0423
M753001150004	11,5	3	1000	€ 0,0441
M753001200004	12	3	1000	€ 0,0453
M753001300004	13	3	1000	€ 0,0483
M753001400004	14	3	1000	€ 0,0513
M753001500004	15	3	1000	€ 0,0543
M753001600004	16	3	1000	€ 0,0604
M753001700004	17	3	1000	€ 0,0652
M753001800004	18	3	1000	€ 0,0676
M753001850004	18,5	3	1000	€ 0,0694
M753001900004	19	3	1000	€ 0,0694
M753001920004	19,2	3	1000	€ 0,0694
M753002000004	20	3	1000	€ 0,0754
M753002050004	20,5	3	1000	€ 0,0779
M753002200004	22	3	1000	€ 0,0797
M753002220004	22,2	3	1000	€ 0,0809
M753002300004	23	3	1000	€ 0,0827
M753002400004	24	3	1000	€ 0,0863
M753002420005	24,2	3	1000	€ 0,0875
M753002500004	25	3	1000	€ 0,0894
M753002620004	26,2	3	1000	€ 0,0996
M753002700004	27	3	1000	€ 0,1014
M753002800004	28	3	500	€ 0,1032
M753003000004	30	3	500	€ 0,1063
M753003050004	30,5	3	500	€ 0,1087
M753003220004	32,2	3	500	€ 0,1129
M753003420004	34,2	3	500	€ 0,1256
M753003500004	35	3	500	€ 0,1279
M753003600004	36	3	500	€ 0,1298
M753003700004	37	3	500	€ 0,1310
M753003800004	38	3	500	€ 0,1328
M753003920004	39,2	3	500	€ 0,1340
M753004000004	40	3	500	€ 0,1353
M753004200004	42	3	500	€ 0,1539
M753004300004	43	3	500	€ 0,1636
M753004420004	44,2	3	500	€ 0,1654
M753004500004	45	3	500	€ 0,1751
M753004950004	49,5	3	500	€ 0,1950
M753005200004	52	3	250	€ 0,2053
M753005450004	54,5	3	250	€ 0,2064

O-RINGS METRICI NBR 70sh
O-RINGS METRIC STANDARDS NBR 70sh



Codice Code	Ø Interno Inner Ø	Ø Corda Cord Ø	Lotto Minimo Min. Quantity	Prezzo Unit Price
M753005720004	57	3	250	€ 0,2100
M753005900004	59	3	250	€ 0,2125
M753006000004	60	3	250	€ 0,2144
M753006400004	64	3	250	€ 0,2174
M753000650000	65	3	250	€ 0,2234
M753008000004	80	3	250	€ 0,2958
M753008200004	82	3	250	€ 0,3018
M753008450004	84,5	3	250	€ 0,3079
M753009000004	90	3	250	€ 0,3320
M753009450004	94,5	3	250	€ 0,3501
M753010500004	105	3	150	€ 0,4226
M753013950004	139,5	3	100	€ 0,6521
M754001600004	16	4	1000	€ 0,0930
M754001800004	18	4	1000	€ 0,1051
M754002000004	20	4	1000	€ 0,1111
M754002400004	24	4	1000	€ 0,1177
M754002800004	28	4	500	€ 0,1382
M754003000004	30	4	500	€ 0,1425
M754003200004	32	4	500	€ 0,1570
M754003800004	38	4	500	€ 0,1962
M754004000004	40	4	500	€ 0,2100
M754004200004	42	4	500	€ 0,2149
M754004500004	45	4	250	€ 0,2270
M754005000004	50	4	250	€ 0,2505
M754006200004	62	4	250	€ 0,3103
M754007600004	76	4	150	€ 0,3809
M754008000004	80	4	150	€ 0,4105
M754008500004	85	4	150	€ 0,4305
M754009200004	92	4	150	€ 0,4630
M755704420004	44,2	5,7	250	€ 0,2657
M755704530004	45,3	5,7	250	€ 0,2777
M755704920004	49,2	5,7	250	€ 0,2898
M755705230004	52,3	5,7	250	€ 0,3018
M755705420004	54,2	5,7	250	€ 0,3260
M755705530004	55,3	5,7	150	€ 0,3623
M755705920004	59,2	5,7	150	€ 0,3864
M755706200004	62	5,7	150	€ 0,4347
M755706230004	62,3	5,7	150	€ 0,4347
M755706420004	64,2	5,7	150	€ 0,4830

O-RINGS METRICI NBR 70sh
O-RINGS METRIC STANDARDS NBR 70sh



Codice Code	Ø Interno Inner Ø	Ø Corda Cord Ø	Lotto Minimo Min. Quantity	Prezzo Unit Price
M755706900004	69	5,7	150	€ 0,5132
M755706920004	69,2	5,7	150	€ 0,5132
M755707420004	74,2	5,7	150	€ 0,5312
M755707920004	79,2	5,7	150	€ 0,5736
M755708400004	84	5,7	100	€ 0,6037
M755708930004	89,3	5,7	100	€ 0,6339
M755709430004	94,3	5,7	100	€ 0,6521
M755709930004	99,3	5,7	100	€ 0,6641
M755710430004	104,3	5,7	100	€ 0,6882
M755710900004	109	5,7	100	€ 0,7245
M755711400004	114	5,7	100	€ 0,7486
M755711900004	119	5,7	100	€ 0,8150
M755712400004	124	5,7	100	€ 0,8754
M755712930004	129,3	5,7	100	€ 0,9056
M755713430004	134,3	5,7	50	€ 0,9659
M755713930004	139,3	5,7	50	€ 0,9961
M755714430004	144,3	5,7	50	€ 1,1168
M755714930004	149,3	5,7	50	€ 1,1470
M755715430004	154,3	5,7	50	€ 1,2071
M755715930004	159,3	5,7	50	€ 1,3586
M755716430004	164,3	5,7	50	€ 1,4485
M755716930004	169,3	5,7	50	€ 1,5092
M755717430004	174,3	5,7	50	€ 1,6305
M755717930004	179,3	5,7	50	€ 1,6899

CORDA NBR 70sh
NBR CORD-RING 70sh



Codice Code	Ø Corda mm Cord Ø mm	Tolleranze su Ø Corda Tolerance of cord Ø	Lotto Minimo mt Min. Quantity mtr	Prezzo mt Unit Price mtr
M215588141000	1,78	± 0,30	50	€ 0,716
M215588142000	2,00	± 0,30	50	€ 0,716
M215588144110	2,62	± 0,35	50	€ 0,835
M215588145000	3,00	± 0,35	50	€ 0,955
M215588146110	3,53	± 0,35	50	€ 1,253
M215588147000	4,00	± 0,40	30	€ 1,313
M215588149000	5,00	± 0,40	30	€ 1,790
M215588149110	5,34	± 0,40	30	€ 1,790
M215588150000	6,00	± 0,50	30	€ 2,626
M215588150110	6,99	± 0,50	15	€ 3,521
M215588152000	8,00	± 0,50	15	€ 4,356
M215588153000	9,00	± 0,50	15	€ 5,669
M215588154000	10,00	± 0,60	15	€ 6,863
M215588156000	12,00	± 0,60	15	€ 9,309
M215588159000	15,00	± 0,60	15	€ 13,964

KIT O-RINGS TIPO G
KIT O-RINGS TYPE G



Codice Code	Descrizione Description	Prezzo Unit Price
S750092000000	nr. 382 O- rings nbr 70 sh	€ 31,61
S750092000001	nr. 382 O- rings fkm 80 sh	€ 232,58

Descrizione Kit
Kit Description

Ø 2,9x1,78 pz 20 RIF. 2012	Ø 4,48x1,78 pz 20 RIF. 2018	Ø 6,07x1,78 pz 20 RIF. 2025	Ø 7,66x1,78 pz 20 RIF. 2031	Ø 9,25x1,78 pz 20 RIF. 2037
Ø 3,68x1,78 pz 20 RIF. 2015	Ø 9,19x2,62 pz 13 RIF. 3037	Ø 10,78x2,62 pz 13 RIF. 3043	Ø 12,31x2,62 pz 13 RIF. 3050	Ø 13,95x2,62 pz 13 RIF. 3056
Ø 15,54x2,62 pz 13 RIF. 3062	Ø 17,13x2,62 pz 13 RIF. 3068	Ø 18,72x2,62 pz 13 RIF. 3075	Ø 36,10x3,53 pz 10 RIF. 4143	Ø 37,69x3,53 pz 10 RIF. 4150
Ø 18,64x3,53 pz 10 RIF. 4106	Ø 20,22x3,53 pz 10 RIF. 4081	Ø 21,82x3,53 pz 10 RIF. 4087	Ø 23,40x3,53 pz 10 RIF. 4093	Ø 24,99x3,53 pz 10 RIF. 4100
Ø 28,58x3,53 pz 10 RIF. 4106	Ø 28,17x3,53 pz 10 RIF. 4112	Ø 29,75x3,53 pz 10 RIF. 4118	Ø 31,34x3,53 pz 10 RIF. 4125	Ø 32,93x3,53 pz 10 RIF. 4131
Ø 34,52x3,53 pz 10 RIF. 4137	Ø 37,47x5,33 pz 7 RIF. 6150	Ø 40,65x5,33 pz 7 RIF. 6162	Ø 43,82x5,33 pz 7 RIF. 6179	Ø 5,28x1,78 pz 20 RIF. 2021

KIT O-RINGS TIPO H
KIT O-RINGS TYPE H

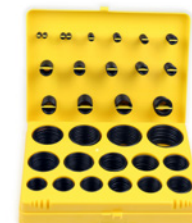

Codice Code	Descrizione Description	Prezzo Unit Price
S750091000000	nr. 404 O- rings nbr 70 sh	€ 31,61
S750091000001	nr. 404 O- rings fkm 80 sh	€ 232,58

Descrizione Kit
Kit Description

Ø 3x2 pz 18	Ø 4x2 pz 18	Ø 5x2 pz 18	Ø 6x2 pz. 18	Ø 7x2 pz. 17
Ø 8x2 pz. 17	Ø 10x2 pz. 17	Ø 10x2,5 pz. 14	Ø 11x2,5 pz. 14	Ø 12x2,5 pz. 14
Ø 14x2,5 pz. 14	Ø 16x2,5 pz. 14	Ø 17x2,5 pz. 14	Ø 19x2,5 pz. 14	Ø 19x3 pz. 12
Ø 20x3 pz. 12	Ø 22x3 pz. 12	Ø 24x3 pz. 12	Ø 25x3 pz. 12	Ø 27x3 pz. 12
Ø 28x3 pz. 12	Ø 30x3 pz. 12	Ø 32x3 pz. 12	Ø 33x3 pz. 12	Ø 35x3 pz. 12
Ø 36x3 pz. 12	Ø 38x3 pz. 12	Ø 38x4 pz. 9	Ø 42x4 pz. 9	Ø 45x4 pz. 9

O-RINGS FKM 70sh
FKM O-RINGS 70sh



Codice Code	GB Standard		USA Standard	Ø Interno Inner Ø	Ø Corda Cord Ø	Confezione Package	Prezzo Unit Price
M751802007094	2007		2-004	1,78	1,78	1000	€ 0,0466
M751802010094	2010		2-005	2,57	1,78	1000	€ 0,0466
M751802012094	2012	101	2-006	2,90	1,78	1000	€ 0,0477
M751802015094	2015	102	2-007	3,69	1,78	1000	€ 0,0489
M751802018094	2018	103	2-008	4,48	1,78	1000	€ 0,0489
M751802021094	2021	104	2-009	5,28	1,78	1000	€ 0,0545
M751802025094	2025	105	2-010	6,07	1,78	1000	€ 0,0601
M751802028094		106	5-052	6,75	1,78	1000	€ 0,0659
M751802031094	2031	107	2-011	7,66	1,78	500	€ 0,0727
M751802033094		108	5-612	8,73	1,78	500	€ 0,0839
M751802037094	2037	110	2-012	9,25	1,78	500	€ 0,0950
M751802043094	2043		2-013	10,82	1,78	500	€ 0,1048
M751802046094		114	5-613	11,11	1,78	500	€ 0,1160
M751802050094	2050		2-014	12,42	1,78	500	€ 0,1258
M751802056094	2056		2-015	14,00	1,78	500	€ 0,1323
M751802062094	2062		2-016	15,60	1,78	300	€ 0,1421
M751802068094	2068		2-017	17,17	1,78	300	€ 0,1542
M751802075094	2075		2-018	18,77	1,78	300	€ 0,1689
M751802081094	2081		2-019	20,35	1,78	300	€ 0,1852
M751802087094	2087		2-020	21,95	1,78	300	€ 0,2097
M751802093094	2093		2-021	23,52	1,78	300	€ 0,2458
M751802100094	2100		2-022	25,12	1,78	150	€ 0,2819
M751802106094	2106		2-023	26,70	1,78	150	€ 0,3099
M751802112094	2112		2-024	28,30	1,78	150	€ 0,3378
M751802118094	2118		2-025	29,87	1,78	150	€ 0,3658
M751802125094	2125		2-026	31,47	1,78	150	€ 0,3937
M751802131094	2131		2-027	33,05	1,78	150	€ 0,4217
M751802137094	2137		2-028	34,65	1,78	150	€ 0,4543
M751802150094	2150		2-029	37,82	1,78	150	€ 0,5242
M751802162094	2162		2-030	41,00	1,78	150	€ 0,6640
M751802175094	2175		2-031	44,17	1,78	150	€ 0,6990
M751802187094	2187		2-032	47,37	1,78	150	€ 0,7922
M751802200094	2200		2-033	50,52	1,78	150	€ 0,8854
M751802212094	2212		2-034	53,67	1,78	150	€ 0,9786
M751802225094	2225		2-035	56,87	1,78	150	€ 1,0951
M751802237094	2237		2-036	60,04	1,78	150	€ 1,1649
M751802250094	2250		2-037	63,22	1,78	150	€ 1,2116
M751802262094	2262		2-038	66,40	1,78	150	€ 1,2116
M751802275094	2275		2-039	69,57	1,78	100	€ 1,3047



O-RINGS FKM 70sh
FKM O-RINGS 70sh

Codice Code	GB Standard		USA Standard	Ø Interno Inner Ø	Ø Corda Cord Ø	Confezione Package	Prezzo Unit Price
M751802287094	2287		2-040	72,76	1,78	100	€ 1,3047
M751802300094	2300		2-041	75,94	1,78	100	€ 1,5610
M751807900094	2312			79,00	1,78	100	€ 1,5610
M751802325094	2325		2-042	82,28	1,78	100	€ 1,6077
M751802350094	2350		2-043	88,64	1,78	100	€ 1,6309
M751802362094	2362			91,70	1,78	100	€ 1,7474
M751802375094	2375		2-044	95,00	1,78	100	€ 1,8173
M751805380094	2387			98,05	1,78	100	€ 1,9339
M751802400094	2400		2-045	101,34	1,78	100	€ 2,0736
M751802412094	2412			104,40	1,78	100	€ 2,0736
M751802425094	2425		2-046	107,70	1,78	100	€ 2,0736
M751802450094	2450		2-047	114,00	1,78	50	€ 2,2134
M751802462094	2462			117,10	1,78	50	€ 2,2134
M751802475094	2475		2-048	120,37	1,78	50	€ 2,2601
M751802500094	2500		2-049	126,72	1,78	50	€ 2,3299
M751802525094	2525		2-050	133,10	1,78	50	€ 2,3765
M751802562094	2562			142,11	1,78	50	€ 2,5163
M751802637094	2637			161,16	1,78	30	€ 3,2619
M751802652094	2652			164,34	1,78	30	€ 3,3085
M752602840094				2,84	2,62	500	€ 0,0932
M752603630094				3,63	2,62	500	€ 0,0932
M752604420094				4,42	2,62	500	€ 0,1142
M752605230094				5,23	2,62	500	€ 0,1211
M752600602094				6,02	2,62	500	€ 0,1281
M752603030094				7,60	2,62	500	€ 0,1351
M752603036094		109	2-110	9,13	2,62	300	€ 0,1398
M752603037094	3037	111	2-110	9,19	2,62	300	€ 0,1398
M752603039094		112	5-614	9,92	2,62	300	€ 0,1514
M752603043094	3043	113	2-111	10,78	2,62	300	€ 0,1631
M752603047094		115	5-615	11,91	2,62	300	€ 0,1747
M752603050094	3050	116	2-112	12,37	2,62	300	€ 0,1864
M752603053094	3053	117	5-616	13,10	2,62	300	€ 0,1957
M752603056094	3056	118	2-113	13,95	2,62	300	€ 0,2027
M752601508094		119	5-243	15,08	2,62	300	€ 0,2120
M752601140094	3062	120	2-114	15,54	2,62	300	€ 0,2213
M752603064094		121	5-617	15,88	2,62	300	€ 0,2306
M752603068094	3068	122	2-115	17,13	2,62	300	€ 0,2400
M752603070094		123	5-256	17,86	2,62	150	€ 0,2446
M752601872094	3075	124	2-116	18,72	2,62	150	€ 0,2539

O-RINGS FKM 70sh
FKM O-RINGS 70sh



Codice Code	GB Standard		USA Standard	Ø Interno Inner Ø	Ø Corda Cord Ø	Confezione Package	Prezzo Unit Price
M752603081094	3081	127	2-117	20,24	2,62	150	€ 0,2749
M752603083094		128	2-117	20,63	2,62	150	€ 0,2959
M752603087094	3087		2-118	22,00	2,62	150	€ 0,3192
M752603089094		130	2-118	22,22	2,62	150	€ 0,3399
M752603093094	3093		2-119	23,47	2,62	150	€ 0,3611
M752603095094		132	2-119	23,81	2,62	150	€ 0,3821
M752603100094	3100		2-120	25,07	2,62	150	€ 0,4031
M752603106094	3106		2-121	26,65	2,62	100	€ 0,4240
M752603112094	3112		2-122	28,25	2,62	100	€ 0,4450
M752603118094	3118		2-123	29,82	2,62	100	€ 0,4706
M752603125094	3125		2-124	31,42	2,62	100	€ 0,4963
M752603131094	3131		2-125	32,99	2,62	100	€ 0,5219
M752603137094	3137		2-126	34,60	2,62	100	€ 0,5452
M752603143094	3143		2-127	36,17	2,62	100	€ 0,5662
M752603150094	3150		2-128	37,77	2,62	100	€ 0,5918
M752603156094	3156		2-129	39,34	2,62	100	€ 0,6127
M752604100004	3162		2-130	40,95	2,62	100	€ 0,6384
M752603168094	3168		2-131	42,52	2,62	100	€ 0,6640
M752603175094	3175		2-132	44,12	2,62	50	€ 0,7083
M752603181094	3181		2-133	45,69	2,62	50	€ 0,7572
M752603187094	3187		2-134	47,30	2,62	50	€ 0,8201
M752603193094	3193		2-135	48,89	2,62	50	€ 0,8737
M752603200094	3200		2-136	50,47	2,62	50	€ 0,9273
M752603206094	3206		2-137	52,07	2,62	50	€ 0,9762
M752603212094	3212		2-138	53,65	2,62	50	€ 1,0135
M752603218094	3218		2-139	55,25	2,62	50	€ 1,0508
M752603225094	3225		2-140	56,82	2,62	50	€ 1,0811
M752603231095	3231		2-141	58,42	2,62	50	€ 1,1254
M752603237094	3237		2-142	60,00	2,62	30	€ 1,1719
M752603243094	3243		2-143	61,60	2,62	30	€ 1,2162
M752603250094	3250		2-144	63,17	2,62	30	€ 1,2372
M752603256094	3256		2-145	64,77	2,62	30	€ 1,2512
M752603262094	3262		2-146	66,35	2,62	30	€ 1,2651
M752603268094	3268		2-147	67,95	2,62	30	€ 1,2838
M752603275094	3275		2-148	69,52	2,62	30	€ 1,3024
M752603281094	3281		2-149	71,12	2,62	30	€ 1,3188
M752603287094	3287		2-150	72,70	2,62	30	€ 1,3979
M752603300094	3300		2-151	75,88	2,62	30	€ 1,5145
M752603325094	3325		2-152	82,22	2,62	30	€ 1,6309
M752603350094	3350		2-153	88,58	2,62	30	€ 1,8173



O-RINGS FKM 70sh
FKM O-RINGS 70sh

Codice Code	GB Standard		USA Standard	Ø Interno Inner Ø	Ø Corda Cord Ø	Confezione Package	Prezzo Unit Price
M752603375094	3375		2-154	94,93	2,62	20	€ 1,8173
M752603400094	3400		2-155	101,28	2,62	20	€ 1,8173
M752603425094	3425		2-156	107,63	2,62	20	€ 1,8872
M752603450094	3450		2-157	113,98	2,62	20	€ 1,9571
M752603475094	3475		2-158	120,33	2,62	20	€ 2,3066
M752603500094	3500		2-159	126,67	2,62	20	€ 2,3183
M752603525094	3525		2-160	133,00	2,62	20	€ 2,5629
M752603550094	3550		2-161	139,38	2,62	20	€ 2,7494
M752603575094	3575		2-162	145,72	2,62	20	€ 2,9357
M752603600094	3600		2-163	152,07	2,62	20	€ 3,1221
M752603625094	3625		2-164	158,42	2,62	20	€ 3,3085
M752603650094	3650		2-165	164,77	2,62	20	€ 3,4949
M752603675094	3675		2-166	171,13	2,62	20	€ 3,7000
M752603700094	3700		2-167	177,47	2,62	20	€ 3,8071
M752603725094	3725		2-168	183,83	2,62	20	€ 3,9376
M752603750094	3750		2-169	190,18	2,62	20	€ 4,0774
M752603775094	3775		2-170	196,53	2,62	15	€ 4,2056
M752603800094	3800		2-171	202,88	2,62	15	€ 4,4712
M752603825094	3825		2-172	209,22	2,62	15	€ 4,9138
M752603850094	3850		2-173	215,58	2,62	15	€ 5,0793
M752603875094	3875		2-174	221,92	2,62	15	€ 5,2471
M752603900094	3900		2-175	228,27	2,62	30	€ 6,9736
M752603925094	3925		2-176	234,62	2,62	30	€ 9,0542
M752603950094	3950		2-177	240,97	2,62	30	€ 9,1847
M752603975094	3975		2-178	247,32	2,62	30	€ 9,2965
M753500434094				4,34	3,53	500	€ 0,1165
M753500594094				5,94	3,53	500	€ 0,1235
M753507520094	4028		2-203	7,52	3,53	500	€ 0,1468
M753500912094	4036		2-204	9,12	3,53	500	€ 0,1677
M753501069094			2-205	10,69	3,53	500	€ 0,1957
M753501229094	4050		2-206	12,29	3,53	100	€ 0,3285
M753504055094	4055		2-207	13,87	3,53	100	€ 0,3495
M753504061094	4061		2-208	15,47	3,53	100	€ 0,3681
M753504067094	4067		2-209	17,04	3,53	100	€ 0,3891
M753504075194	4075	125	2-210	18,64	3,53	100	€ 0,4124
M753504081094	4081	126	2-211	20,22	3,53	100	€ 0,4543
M753504087094	4087	129	2-212	21,82	3,53	100	€ 0,4939
M753504093094	4093	131	2-213	23,40	3,53	100	€ 0,5382
M753504100094	4100	133	2-214	24,99	3,53	100	€ 0,5801
M753504103094		134	5-618	25,80	3,53	100	€ 0,6151

O-RINGS FKM 70sh
FKM O-RINGS 70sh



Codice Code	GB Standard		USA Standard	Ø Interno Inner Ø	Ø Corda Cord Ø	Confezione Package	Prezzo Unit Price
M753504106094	4106	135	2-215	26,57	3,53	100	€ 0,6524
M753504112094	4112	136	2-216	28,17	3,53	100	€ 0,6920
M753504118094	4118	137	2-217	29,75	3,53	50	€ 0,7223
M753504125094	4125	138	2-218	31,34	3,53	50	€ 0,7549
M753504131094	4131	139	2-219	32,93	3,53	50	€ 0,7875
M753504137094	4137	140	2-220	34,52	3,53	50	€ 0,8061
M753504143094	4143	141	2-221	36,10	3,53	50	€ 0,8225
M753504150094	4150	142	2-222	37,69	3,53	50	€ 0,8388
M753504156094		144	5-321	39,69	3,53	50	€ 0,8597
M753504162094	4162		2-223	40,87	3,53	50	€ 0,8784
M753504166094		146	2-223	41,28	3,53	50	€ 0,8970
M753504170094		147	5-332	42,86	3,53	50	€ 0,9156
M753504175094	4175		2-224	44,04	3,53	50	€ 0,9366
M753504178094		149	2-224	44,45	3,53	50	€ 0,9576
M753504183094		150	5-035	46,04	3,53	50	€ 0,9972
M753504187094	4187		2-225	47,23	3,53	50	€ 1,0368
M753504190094		152	2-225	47,62	3,53	50	€ 1,0508
M753504196094		153	5-701	49,21	3,53	50	€ 1,0834
M753504200094	4200		2-226	50,40	3,53	50	€ 1,1254
M753504202094		155	2-226	50,80	3,53	30	€ 1,1533
M753504208094		156	5-037	52,39	3,53	30	€ 1,1836
M753504212094	4212		2-227	53,57	3,53	30	€ 1,2139
M753504214094		158	2-227	53,97	3,53	30	€ 1,2465
M753504220094		159		55,56	3,53	30	€ 1,2815
M753504225094	4225		2-228	56,75	3,53	30	€ 1,3188
M753504228094		161	2-228	57,15	3,53	30	€ 1,3490
M753504233094		162	5-702	58,74	3,53	30	€ 1,3817
M753504237094	4237		2-229	59,92	3,53	30	€ 1,4143
M753504240094		164	2-229	60,32	3,53	30	€ 1,4376
M753504245094		165		61,91	3,53	30	€ 1,4725
M753504250094	4250		2-230	63,10	3,53	30	€ 1,5075
M753504252094		167	2-230	63,50	3,53	30	€ 1,5145
M753504258094		168	5-703	65,10	3,53	30	€ 1,5401
M753504262094	4262		2-231	66,27	3,53	30	€ 1,5657
M753504264094		170	2-231	66,68	3,53	30	€ 1,5913
M753504270094		171	5-361	68,26	3,53	30	€ 1,6170
M753504275094	4275		2-232	69,44	3,53	30	€ 1,6426
M753504278094		173	2-232	69,85	3,53	30	€ 1,6915
M753504282094		174	5-704	71,44	3,53	30	€ 1,7428
M753504287094	4287		2-233	72,62	3,53	20	€ 1,7940



O-RINGS FKM 70sh
FKM O-RINGS 70sh

Codice Code	GB Standard	USA Standard	Ø Interno Inner Ø	Ø Corda Cord Ø	Confezione Package	Prezzo Unit Price
M753504290094	176	2-233	73,02	3,53	20	€ 1,8383
M753504294094	177	5-705	74,61	3,53	20	€ 1,8872
M753504300094	4300	2-234	75,80	3,53	20	€ 1,9362
M753504312094	4312	2-235	78,97	3,53	20	€ 1,9571
M753504325094	4325	2-236	82,14	3,53	20	€ 2,0014
M753504337094	4337	2-237	85,32	3,53	20	€ 2,0503
M753504350094	4350	2-238	88,50	3,53	20	€ 2,1086
M753504362094	4362	2-239	91,67	3,53	20	€ 2,1715
M753504375094	4375	2-240	94,84	3,53	20	€ 2,2554
M753504387094	4387	2-241	98,02	3,53	20	€ 2,3299
M753500440094	4400	2-242	101,20	3,53	20	€ 2,3975
M753504412094	4412	2-243	104,40	3,53	20	€ 2,4720
M753504425094	4425	2-244	107,50	3,53	20	€ 2,5513
M753504437094	4437	2-245	110,72	3,53	20	€ 2,7447
M753504450094	4450	2-246	113,90	3,53	30	€ 2,7959
M753504462094	4462	2-247	117,10	3,53	30	€ 2,8519
M753504475094	4475	2-248	120,24	3,53	30	€ 2,8938
M753504487094	4487	2-249	123,40	3,53	30	€ 2,9520
M753504500095	4500	2-250	126,60	3,53	30	€ 3,0010
M753512980094	4512	2-251	129,80	3,53	30	€ 3,0452
M753504525094	4525	2-252	132,94	3,53	30	€ 3,1221
M753504537094	4537	2-253	136,12	3,53	30	€ 3,1920
M753504550094	4550	2-254	139,30	3,53	30	€ 3,3295
M753504562094	4562	2-255	142,50	3,53	30	€ 3,4623
M753504575094	4575	2-256	145,60	3,53	30	€ 3,6021
M753504587094	4587	2-257	148,82	3,53	30	€ 3,6534
M753504600095	4600	2-258	152,00	3,53	30	€ 3,7163
M753504625094	4625	2-259	158,35	3,53	30	€ 3,7768
M753504650094	4650	2-260	164,70	3,53	30	€ 3,8328
M753504675094	4675	2-261	171,05	3,53	30	€ 3,8933
M753504700094	4700	2-262	177,40	3,53	30	€ 4,0075
M753504725094	4725	2-263	183,75	3,53	20	€ 4,1427
M753503750094	4750	2-264	190,10	3,53	20	€ 4,2871
M753504775094	4775	2-265	196,45	3,53	20	€ 4,4269
M753504800094	4800	2-266	202,80	3,53	20	€ 4,7065
M753504825094	4825	2-267	209,15	3,53	20	€ 5,1725
M753504850094	4850	2-268	215,50	3,53	20	€ 5,3356
M753502690094	4875	2-269	221,85	3,53	20	€ 5,5220
M753504900094	4900	2-270	228,20	3,53	10	€ 7,3394
M753504925094	4925	2-271	234,55	3,53	10	€ 9,5295

O-RINGS FKM 70sh
FKM O-RINGS 70sh



Codice Code	GB Standard		USA Standard	Ø Interno Inner Ø	Ø Corda Cord Ø	Confezione Package	Prezzo Unit Price
M753504950094	4950		2-272	240,90	3,53	10	€ 9,6693
M753504975094	4975		2-273	247,20	3,53	10	€ 9,7858
M753541000094	41000		2-274	253,60	3,53	10	€ 9,9023
M753502750094	41050		2-275	266,30	3,53	10	€ 10,1353
M753541100094	41100		2-276	279,00	3,53	10	€ 10,5314
M753541150094	41150		2-277	291,70	3,53	10	€ 10,9508
M753541200094	41200		2-278	304,39	3,53	10	€ 11,3469
M753541300094	41300		2-279	329,80	3,53	10	€ 11,7663
M753541400094	41400		2-280	355,20	3,53	10	€ 13,7468
M753541500094	41500		2-281	380,60	3,53	10	€ 15,1447
M753541600094	41600		2-282	405,26	3,53	10	€ 15,7272
M753541700094	41700		2-283	430,66	3,53	10	€ 16,5427
M753541800094	41800		2-284	456,06	3,53	10	€ 19,9211
M755301207094				12,07	5,34	150	€ 0,6524
M755301364094				13,64	5,34	150	€ 0,7455
M755301524094				15,24	5,34	150	€ 0,8854
M755301681094				16,81	5,34	150	€ 0,9320
M755301841094				18,42	5,34	150	€ 0,9786
M755301999094				19,99	5,34	150	€ 1,1416
M755302159094				21,59	5,34	100	€ 1,2815
M755302316094				23,16	5,34	100	€ 1,3514
M755302477094				24,77	5,34	100	€ 1,4213
M755302634094				26,34	5,34	100	€ 1,4446
M755302794094				27,94	5,34	100	€ 1,5145
M755302952094				29,51	5,34	100	€ 1,6077
M755331120094				31,12	5,34	100	€ 1,6309
M755303269094				32,69	5,34	100	€ 1,6542
M755303429094				34,29	5,34	60	€ 1,7009
M755306150094	6150	143	2-325	37,47	5,34	60	€ 1,7241
M755306162094	6162	145	2-326	40,65	5,34	60	€ 1,8127
M755306175095	6175	148	2-327	43,82	5,34	60	€ 1,8989
M755306187094	6187	151	2-328	47,00	5,34	60	€ 2,0154
M755306200094	6200	154	2-329	50,16	5,34	60	€ 2,0970
M755306212094	6212	157	2-330	53,34	5,34	60	€ 2,1761
M755306225094	6225	160	2-331	56,52	5,34	60	€ 2,2577
M755306237094	6237	163	2-332	59,69	5,34	60	€ 2,3253
M755306250094	6250	166	2-333	62,87	5,34	40	€ 2,3975
M755306262094	6262	169	2-334	66,04	5,34	40	€ 2,4837
M755306275094	6275	172	2-335	69,22	5,34	40	€ 2,5699
M755306287094	6287	175	2-336	72,39	5,34	40	€ 2,6678
M755306293094		178		74,63	5,34	40	€ 2,7726
M755306300094	6300	179	2-337	75,57	5,34	40	€ 2,8705



O-RINGS FKM 70sh
FKM O-RINGS 70sh

Codice Code	GB Standard		USA Standard	Ø Interno Inner Ø	Ø Corda Cord Ø	Confezione Package	Prezzo Unit Price
M755306312095	6312	180	2-338	78,74	5,34	40	€ 2,9823
M755306318094		181		79,77	5,34	30	€ 3,1920
M755306325094	6325	182	2-339	81,92	5,34	30	€ 3,2852
M755306337094	6337	183	2-340	85,10	5,34	30	€ 3,3807
M755306350094	6350	184	2-341	88,27	5,34	30	€ 3,4763
M755306356094		185		89,69	5,34	30	€ 3,6464
M755306362094	6362	186	2-342	91,44	5,34	30	€ 3,7978
M755306375094	6375	187	2-343	94,62	5,34	30	€ 3,9446
M755306387094	6387	188	2-344	97,79	5,34	30	€ 4,1356
M755306395094		189		100,00	5,34	20	€ 4,3337
M755306400094	6400	190	2-345	101,00	5,34	20	€ 4,4269
M755306412094	6412	191	2-346	104,10	5,34	20	€ 4,5388
M755306425094	6425	192	2-347	107,32	5,34	20	€ 4,6716
M755306432094		193		109,50	5,34	20	€ 4,7950
M755306437094	6437	194	2-348	110,50	5,34	10	€ 4,8929
M755306450094	6450	195	2-349	113,70	5,34	10	€ 4,9978
M755306460094		199		117,48	5,34	10	€ 5,1189
M755306470094		201		120,70	5,34	10	€ 5,2377
M755312383094		203		123,83	5,34	10	€ 5,3006
M755306490094		206		127,00	5,34	10	€ 5,3542
M755306500094		208		130,20	5,34	10	€ 5,4195
M755306510094		210		133,35	5,34	10	€ 5,4777
M755312383094		213		136,53	5,34	10	€ 5,5406
M755306530094		215		139,70	5,34	10	€ 5,7084
M755306540094		217		142,90	5,34	10	€ 5,9996
M755306550094		219		146,10	5,34	10	€ 6,0928
M755306570094		221		149,23	5,34	10	€ 6,1744
M757008450094	8450	196	2-425	113,70	6,99	5	€ 6,7452
M757008455094		197		114,70	6,99	5	€ 6,8501
M757008462094	8462	198	2-426	116,84	6,99	5	€ 6,9526
M757008475094	8475	200	2-427	120,00	6,99	5	€ 7,1996
M757008487094	8487	202	2-428	123,20	6,99	5	€ 7,4442
M757008490094		204		124,60	6,99	5	€ 7,6166
M757008500094	8500	205	2-429	126,37	6,99	5	€ 7,7121
M757008512094	8512	207	2-430	129,50	6,99	5	€ 7,8123
M757008525094	8525	209	2-431	132,72	6,99	5	€ 7,9102
M757008530094		211		134,50	6,99	5	€ 8,0174
M757008537094	8537	212	2-432	135,90	6,99	5	€ 8,1269
M757008550094	8550	214	2-433	139,07	6,99	5	€ 8,2713
M757008562094	8562	216	2-434	142,24	6,99	5	€ 8,6488
M757008575094	8575	218	2-435	145,42	6,99	5	€ 8,9004
M757008587094	8587	220	2-436	148,60	6,99	5	€ 9,1101

O-RINGS FKM 70sh
FKM O-RINGS 70sh



Codice Code	GB Standard		USA Standard	Ø Interno Inner Ø	Ø Corda Cord Ø	Confezione Package	Prezzo Unit Price
M757008600094	8600	222	2-437	151,77	6,99	5	€ 9,3571
M757008615094		223		155,60	6,99	5	€ 9,5412
M757008625094	8625	224	2-438	158,10	6,99	5	€ 9,7206
M757008630094		225		159,50	6,99	5	€ 9,7765
M757008640094		226		161,90	6,99	5	€ 9,8324
M757008650094	8650	227	2-439	164,47	6,99	5	€ 9,9163
M757008655094		228		166,70	6,99	5	€ 10,0421
M757008665094		229		168,30	6,99	5	€ 10,1772
M757008675094	8675	230	2-440	170,82	6,99	5	€ 10,3031
M757008685094		231		174,60	6,99	5	€ 10,4848
M757008700094	8700	232	2-441	177,17	6,99	4	€ 10,6712
M757008715094		233		181,00	6,99	4	€ 10,8576
M757008725094	8725	234	2-442	183,52	6,99	4	€ 11,0626
M757008740094		235		187,30	6,99	4	€ 11,2071
M757008750094	8750	236	2-443	189,90	6,99	4	€ 11,3469
M757008760094		237		193,70	6,99	4	€ 11,5216
M757008775094	8775	238	2-444	196,22	6,99	4	€ 11,6777
M757008785094		239		200,00	6,99	4	€ 11,8944
M757008800094	8800	240	2-445	202,57	6,99	4	€ 12,4979
M757008825094	8825	241		208,92	6,99	4	€ 12,7588
M757008850094	8850	242	2-446	215,27	6,99	4	€ 13,0477
M757008875094	8875	243		221,62	6,99	4	€ 14,6508
M757008900094	8900	244	2-447	227,90	6,99	4	€ 15,0166
M757008925094	8925	245		234,30	6,99	4	€ 15,3777
M757008950094	8950	246	2-448	240,70	6,99	2	€ 19,6276
M757008975094	8975	247		247,00	6,99	2	€ 19,8163
M757081000094	81000	248	2-449	253,57	6,99	2	€ 20,0003
M757081025094	81025	249		259,70	6,99	2	€ 20,2939
M757081050094	81050	250	2-450	266,10	6,99	2	€ 20,6015
M757081075094	81075	251		272,40	6,99	2	€ 20,9696
M757081100094	81100	252	2-451	278,77	6,99	2	€ 21,3773
M757081125094	81125	253		285,10	6,99	2	€ 21,8084
M757081150094	81150	254	2-452	291,50	6,99	2	€ 21,9505
M757081175094	81175	255		297,80	6,99	2	€ 22,1672
M757081200094	81200	256	2-453	304,17	6,99	2	€ 22,6472
M757081250094	81250	257	2-454	316,87	6,99	2	€ 23,1271
M757081300094	81300	258	2-455	329,50	6,99	2	€ 23,6724
M757081350094	81350	259	2-456	342,27	6,99	2	€ 24,4413
M757081400094	81400	260	2-457	354,97	6,99	2	€ 25,0005
M757081450094	81450	261	2-458	367,67	6,99	2	€ 25,7460
M757081500094	81500	262	2-459	380,30	6,99	2	€ 26,4450
M757081550094	81550	263	2-460	393,10	6,99	2	€ 27,2605

V-RINGS

Anelli di tenuta per alberi rotanti prodotti interamente in gomma antiolio, assicurano la tenuta contro fango, polvere, spruzzi d'olio e di acqua. Una soluzione efficace ed economica quale dispositivo di tenuta in diverse applicazioni meccaniche. Vengono prodotti in 2 profili essenziali: VA e VS, entrambi disponibili in tutte le dimensioni standard fino a \varnothing 200 mm. A richiesta produciamo V-Rings in viton, silicone e altre mescole.

Sealing rings for rotating shafts entirely made of oil-resistant rubber, ensure the tightness against dirt, dust, oil and water splashes. An efficient and cheap solution as sealing device with various mechanical applications. They come into two basic versions: VA and VS and they're available in all standard sizes up to 200 mm diameter. Upon request we produce Viton, silicone V-Rings and other compounds.



V-RINGS VA
V-RINGS TYPE VA



Codice Code	Tipo Type	D1	D	C	A	B	Q.tà Q.ty	Prezzo Unit Price
M741000320737	VA-4	3,5-4,5	3,2	2	2,4	3,7	100	0,3361
M741000400837	VA-5	4,5-5,5	4	2	2,4	3,7	100	0,3429
S741000500937	VA-6	5,5-6,5	5	2	2,4	3,7	100	0,3498
S741000610037	VA-7	6,5-8,0	6	2	2,4	3,7	100	0,3566
S741000701137	VA-8	8,0-9,5	7	2	2,4	3,7	100	0,3635
S741009012077	VA-10	9,5-11,5	9	3	3,4	5,5	100	0,3703
S741010516555	VA-12	11,5-12,5	10,5	3	3,4	5,5	100	0,3773
S741012518555	VA-14	13,5-15,5	12,5	3	3,4	5,5	100	0,3840
S741014020055	VA-16	15,5-17,5	14	3	3,4	5,5	100	0,3910
S741016026075	VA-18	17,5-19	16	3	3,4	5,5	100	0,3978
S741018026075	VA-20	19-21	18	4	4,7	7,5	50	0,4733
S741020026075	VA-22	21-24	20	4	4,7	7,5	50	0,5075
S741022030075	VA-25	24-27	22	4	4,7	7,5	50	0,5212
S741025033075	VA-28	27-29	25	4	4,7	7,5	50	0,6379
S741027035075	VA-30	29-31	27	4	4,7	7,5	50	0,6516
S741029030075	VA-32	31-33	29	4	4,7	7,5	50	0,6790
S741031039075	VA-35	33-36	31	4	4,7	7,5	50	0,7132
S741034042075	VA-38	36-38	34	4	4,7	7,5	50	0,7613
S741036046090	VA-40	38-43	36	5	5,5	9,0	50	0,8299
S741040050090	VA-45	43-48	40	5	5,5	9,0	50	0,8436
S741045050090	VA-50	48-53	45	5	5,5	9,0	50	1,0013



V-RINGS VA
V-RINGS TYPE VA

Codice Code	Tipo Type	D1	D	C	A	B	Q.tà Q.ty	Prezzo Unit Price
S741049059090	VA-55	53-58	49	5	5,5	9,0	15	1,0082
S741054064090	VA-60	58-63	54	5	5,5	9,0	15	1,1591
S741058068090	VA-65	63-68	58	5	5,5	9,0	15	1,1796
S741063075011	VA-70	68-73	63	6	6,8	11	15	1,3304
S741067079011	VA-75	73-78	67	6	6,8	11	15	1,5087
S741072084011	VA-80	78-83	72	6	6,8	11	15	1,6322
S741076088011	VA-85	83-88	76	6	6,8	11	15	1,8242
S741081093011	VA-90	88-93	81	6	6,8	11	15	1,8379
S741085097011	VA-95	93-98	85	6	6,8	11	15	1,9202
S741090010211	VA-100	98-105	90	6	6,8	11	15	1,9477
S741099011312	VA-110	105-115	99	7	7,9	12,8	15	2,6609
S741010087012	VA-120	115-125	108	7	7,9	12,8	15	2,8118
S741001707012	VA-130	125-135	117	7	7,9	12,8	15	3,1546
S741012614013	VA-140	135-145	126	7	7,9	12,8	15	3,2232
S741010087016	VA-150	145-155	135	7	7,9	12,8	15	3,2918
S741004408014	VA-160	155-165	144	8	9	14,5	15	4,2519
S741005308014	VA-170	165-175	153	8	9	14,5	15	4,4302
S741006208014	VA-180	175-185	162	8	9	14,5	15	4,8966
S741017118715	VA-190	185-195	171	8	9	14,5	15	5,1023
S741018019615	VA-199	195-210	180	8	9	14,5	15	5,6235

V-RINGS VS
V-RINGS TYPE VS



Codice Code	Tipo Type	D1	D	C	A	B	Q.tà Q.ty	Prezzo Unit Price
S742004008052	VS-5	4,5-5,5	4	2	3,9	5,2	100	€ 0,3292
M742005001052	VS-6	5,5-6,5	5	2	3,9	5,2	100	€ 0,3292
S742006010052	VS-7	6,5-8,0	6	2	3,9	5,2	100	€ 0,3361
S742007011052	VS-8	8,0-9,5	7	2	3,9	5,2	100	€ 0,3429
S742009012077	VS-10	9,5-11,5	9	3	5,6	7,7	100	€ 0,3499
S742010516577	VS-12	11,5-13,5	10,5	3	5,6	7,7	100	€ 0,3635
S742012518577	VS-14	13,5-15,5	12,5	3	5,6	7,7	100	€ 0,4115
S742014020077	VS-16	15,5-17,5	14	3	5,6	7,7	100	€ 0,4251
S742016022010	VS-18	17,5-19	16	3	5,6	7,7	100	€ 0,4733
S742018026010	VS-20	19-21	18	4	7,9	10,5	50	€ 0,5212
S742020028010	VS-22	21-24	20	4	7,9	10,5	50	€ 0,6446
S742022030010	VS-25	24-27	22	4	7,9	10,5	50	€ 0,6858
S742025033010	VS-28	27-29	25	4	7,9	10,5	50	€ 0,7201
S742027035010	VS-30	29-31	27	4	7,9	10,5	50	€ 0,7544
S742029037010	VS-32	31-33	29	4	7,9	10,5	50	€ 0,8367
S742031039010	VS-35	33-36	31	4	7,9	10,5	50	€ 0,8778
S742034044010	VS-38	36-38	34	4	7,9	10,5	50	€ 0,9601
S742036046013	VS-40	38-43	36	5	9,5	13	50	€ 1,0012
S742040050013	VS-45	43-48	40	5	9,5	13	50	€ 1,0424
S742045055013	VS-50	48-53	45	5	9,5	13	50	€ 1,0836
S742050060010	VS-55	53-58	49	5	9,5	13	15	€ 1,1110
S742054064013	VS-60	58-63	54	5	9,5	13	15	€ 1,2619
S742058068013	VS-65	63-68	58	5	9,5	13	15	€ 1,2825
S741063075012	VS-70	68-73	63	6	11,3	15,5	15	€ 1,4814
S742067079015	VS-75	73-78	67	6	11,3	15,5	15	€ 1,6597
S742007193015	VS-80	78-83	72	6	11,3	15,5	15	€ 1,7282
S742076088016	VS-85	83-88	76	6	11,3	15,5	15	€ 1,7556
S742008193015	VS-90	88-93	81	6	11,3	15,5	15	€ 1,7831
M742085010215	VS-95	93-98	85	6	11,3	15,5	15	€ 1,8516
S742090010211	VS-100	98-105	90	6	11,3	15,5	15	€ 2,1945
S742099011318	VS-110	105-115	99	7	13,1	18	15	€ 3,0449
S742010087018	VS-120	115-125	108	7	13,1	18	15	€ 3,5662
S742011707018	VS-130	125-135	117	7	13,1	18	15	€ 3,6347
S742012614018	VS-140	135-145	126	7	13,1	18	15	€ 3,8404
S742013514918	VS-150	145-155	135	7	13,1	18	15	€ 3,9776
S742014001620	VS-160	155-165	144	8	15,0	20,5	15	€ 5,5550
S742015316920	VS-170	165-175	153	8	15,0	20,5	15	€ 5,8292
S742016217820	VS-180	175-185	162	8	15,0	20,5	15	€ 6,0350
S742017118720	VS-190	185-195	171	8	15,0	20,5	15	€ 6,1035
S742018019620	VS-199	195-210	180	8	15,0	20,5	15	€ 6,3093

ANELLI DI TENUTA (PARAOLIO)

OIL SEALS

L'anello di tenuta ha generalmente la funzione di trattenere un fluido impedendone la fuoriuscita. La parte esterna deve garantire un fisso piantaggio nella sede e la sua tenuta ermetica. Il labbro di tenuta, grazie al suo specifico profilo unitamente alla forza radiale esercitata dalla molla e alle caratteristiche dell'elastomero, scorre sull'albero creando una barriera che impedisce la fuoriuscita del fluido da ritenere, sia in condizione statiche che dinamiche. Il suo perfetto funzionamento e la sua durata dipendono da più fattori, quali ad esempio: la geometria ottimale del labbro di tenuta adatto ad ogni specifica applicazione, la forza radiale, la flessibilità del labbro, il materiale con il quale è costruito etc. Nella maggior parte delle applicazioni viene adottata la soluzione con gomma all'esterno che offre una buona tenuta statica e permette lavorazioni più grossolane della sede. Nei casi in cui si debba avere una maggior forza di piantaggio (pressioni interne del liquido, sedi e altezze ridotte, etc.) è consigliabile l'esecuzione con lamiera esterna. Gli anelli di tenuta sono conformi alle prescrizioni dalla norma DIN 3760.

Oil seal has generally the function of retaining a fluid, preventing its leaking. The outside has to ensure a fixed-fitting in the seat and its tightness. Thanks to its specific profile together with the radial force applied by the spring and the characteristics of the elastomer, the sealing lip flows on the shaft creating a barrier that prevents the leakage of the fluid both in static and dynamic condition. Its perfect operation and its duration depend on several factors, such as: the optimum geometry of the sealing lip suitable for any specific application, the radial force, the flexibility of the lip, the material of which it's made of etc. In most applications the solution with rubber is adopted on the outside providing a good static seal and allowing coarser machining of the seat. In cases where it is necessary a bigger driving force (internal pressure of the liquid, low seats and heights, etc.) an external sheet is suggested. The sealing rings are in accordance with the requirements of DIN 3760.



MATERIALI PER ANELLI DI TENUTA

OIL SEAL MATERIALS

Sigla Designation	Descrizione Description
NBR	Miscela di gomma a base di acrilonitrile. Utilizzata di preferenza per tenuta degli olii minerali a delle temperature da -40°C a +120°C. Velocità di rotazione ammessa fino a 12m/sec. È la qualità standard nella maggior parte dei casi di utilizzazione in campo industriale. A acrylonitrile-based rubber compound. Generally used for sealing mineral oils at temperature from -40°C to +120°C. Max. rotation speed 12m/sec. This is the standard quality for most industrial applications.
ACM	Miscela in gomma poliaccrilica. Temperatura massima ammessa fino a circa +150°C. Utilizzabile nei casi di tenuta di olii minerali e sintetici. Velocità di rotazione ammessa fino a 22m/sec. A polyacrylic rubber compound. Maximum working temperature +150°C. Used for sealing mineral and synthetic oils. Max. rotation speed 22m/sec.
VMQ	Miscela a base di silicone. Temperatura massima ammessa fino a +180°C. Utilizzabile nei casi di tenuta di olii minerali. Velocità di rotazione ammessa fino a 35m/sec. A silicon-based compound. Maximum working temperature +180°C. Used for sealing mineral and synthetic oils. Max. rotation speed 35m/sec.
FKM	Miscela a base di fluoelastomero. Temperatura massima ammessa fino a +200°C. Utilizzabile nei casi di tenuta di olii minerali e fluidi aggressivi. Velocità di rotazione ammessa fino a 35m/sec. A fluoelastomer-based compound. Maximum working temperature +200°C. Used for sealing mineral and synthetic oils and aggressive fluids. Max. rotation speed 35m/sec.
ARMATURA METALLICA METAL REINFORCEMENT	Esecuzione normale: Acciaio non legato per imbutitura profonda. Esecuzione speciale: Acciaio inossidabile AISI 302-304 resistente all'acqua marina e per tutte le applicazioni in cui è richiesta protezione alla corrosione delle parti metalliche. Standard construction: unalloyed steel for deep-drawing. Special construction: seawater resistant AISI 302-304 stainless steel, for applications requiring the protection of metal parts from corrosion.
MOLLA SPRING	Esecuzione normale: Acciaio per molle. Esecuzione speciale: Acciaio inossidabile AISI 302-304 per applicazioni in cui è richiesta protezione alla corrosione. Standard construction: steel for springs. Special construction: AISI 302-304 stainless steel for applications requiring corrosion resistance.

ANELLI DI TENUTA VERSIONE STANDARD

STANDARD OIL SEAL DESIGNS



SC

Labbro singolo caricato a molla
Single lip with a garter spring



TC

Doppio labbro caricato a molla
Double lip with a garter spring

TIPOLOGIE DI ANELLI DI TENUTA DISPONIBILI A RICHIESTA
OIL SEALS AVAILABLE ON REQUEST

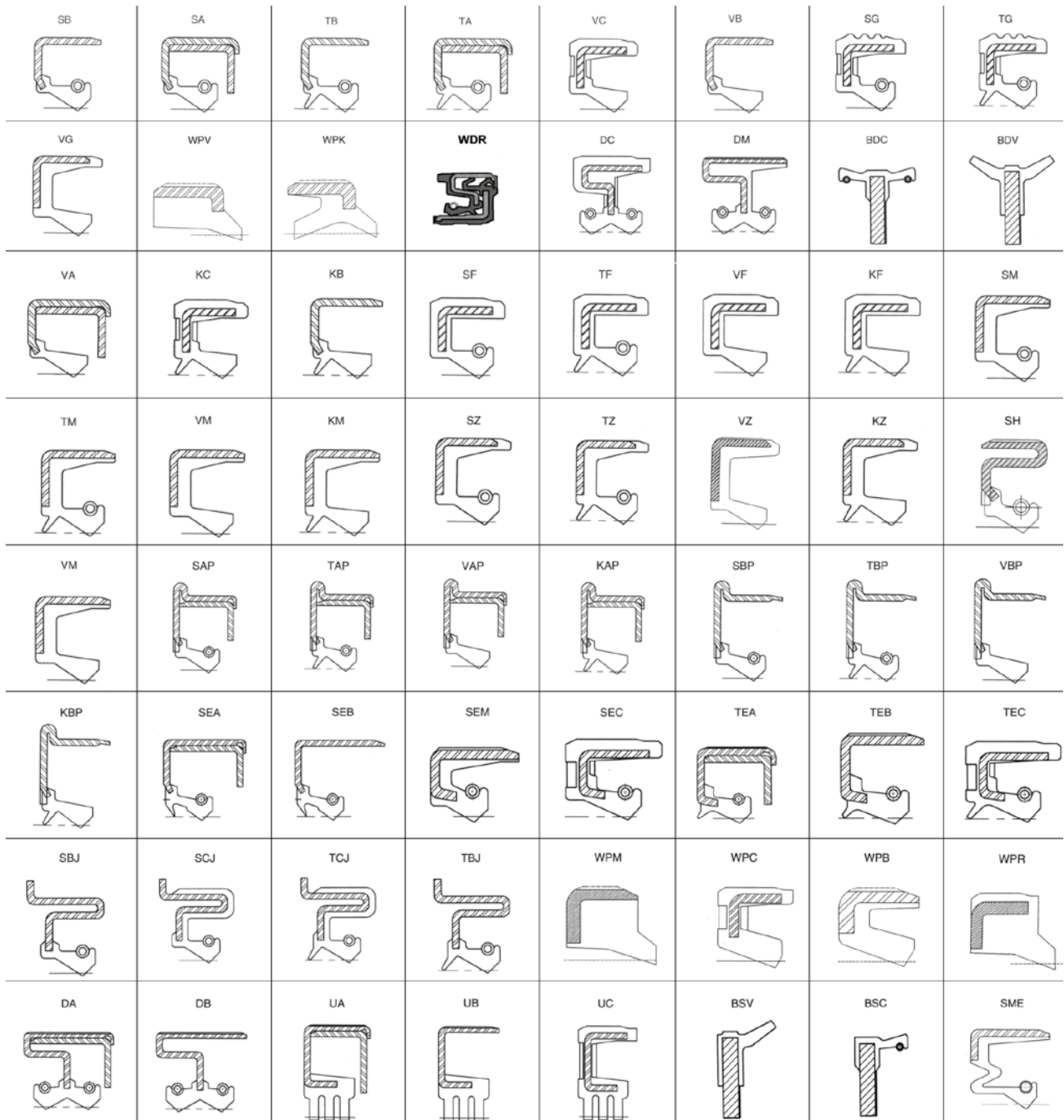

ANELLI DI TENUTA (PARAOLIO) OIL SEALS



Codice Code	Tipo Type	Dimensioni Dimensions			Q.tà Q.ty	Prezzo Unit Price
M730000055010	SC	6	16	7	20	€ 0,8436
M730000080000	SC	6	22	7	20	€ 0,8436
M730000110000	SC	7	22	7	20	€ 0,8436
M730000130000	SC	8	16	7	20	€ 0,8436
M730900130000	TC	8	16	7	20	€ 0,8436
M730000140000	SC	8	18	5	20	€ 0,8436
M730000145000	SC	8	20	7	20	€ 0,8436
M730000150000	SC	8	22	7	20	€ 0,8436
M730900150000	TC	8	22	7	20	€ 0,8436
M730900162900	TC	9	20	7	20	€ 0,8436
M730000163000	SC	9	22	7	20	€ 0,8436
M730000163700	SC	9	26	7	20	€ 0,8436
M730000180000	SC	10	18	4	20	€ 0,8436
M730900175000	TC	10	18	4	20	€ 0,8436
M730000195000	SC	10	19	7	20	€ 0,8436
M730900195000	TC	10	19	7	20	€ 0,8436
M730000200805	SC	10	20	4	20	€ 0,8436
M730000300005	SC	10	22	7	20	€ 0,8436
M730000230000	SC	10	24	7	20	€ 0,8436
M730000230600	SC	10	26	5,5	20	€ 0,8114
M730000230700	SC	10	26	7	20	€ 0,8114
M730000233000	SC	10	30	7	20	€ 0,8114
M730000235005	SC	11	17	4	20	€ 0,8436
M730000236500	SC	11	18	4	20	€ 0,8436
M730000240000	SC	11	22	7	20	€ 0,8436
M730000244000	SC	11	26	7	20	€ 0,8436
M730000262000	SC	12	19	5	20	€ 0,8436
M730000280000	SC	12	20	5	20	€ 0,8436
M730000290000	SC	12	22	5	20	€ 0,8436
M730900029500	TC	12	22	6	20	€ 0,8436
M730900300010	SC	12	22	7	20	€ 0,8436
M730900300000	TC	12	22	7	20	€ 0,8436
M730000310000	SC	12	24	4,5	20	€ 0,8436
M730000330000	SC	12	24	7	20	€ 0,8436
M730900330000	TC	12	24	7	20	€ 0,8436
M730000341000	SC	12	26	5,5	20	€ 0,8114

ANELLI DI TENUTA (PARAOLIO)
OIL SEALS



Codice Code	Tipo Type	Dimensioni Dimensions			Q.tà Q.ty	Prezzo Unit Price
M730900339005	TC	12	26	7	20	€ 0,8114
M730000342000	SC	12	28	7	20	€ 0,8114
M730900342000	TC	12	28	7	20	€ 0,8114
M730000355000	SC	12	30	7	20	€ 0,8114
M730000363000	SC	12	32	7	20	€ 0,8758
M730900363000	TC	12	32	7	20	€ 0,8758
M730900372100	TC	12,5	25	8	20	€ 0,8436
M730000420000	SC	13	26	5	20	€ 0,8114
M730000428000	SC	13	30	7	20	€ 0,8114
M730000430005	SC	14	22	4	20	€ 0,8436
M730000445000	SC	14	24	6	20	€ 0,8436
M730000450010	SC	14	24	7	20	€ 0,8436
M730000461000	SC	14	28	7	20	€ 0,8114
M730000470005	SC	14	30	7	20	€ 0,8114
M730000506000	SC	15	21	4	20	€ 0,8436
M730900510000	TC	15	24	5	20	€ 0,8436
M730000510005	SC	15	24	5	20	€ 0,8436
M730000520005	SC	15	24	7	20	€ 0,8436
M730900520005	TC	15	24	7	20	€ 0,8436
M730000525010	SC	15	25	5	20	€ 0,8436
M730900530000	TC	15	25	7	20	€ 0,8436
M730000560005	SC	15	26	7	20	€ 0,8114
M730900560000	TC	15	26	7	20	€ 0,8114
M730000570000	SC	15	27	7	20	€ 0,8114
M730900570000	TC	15	27	7	20	€ 0,8114
M730000590005	SC	15	30	4,5	20	€ 0,8114
M730000600015	SC	15	30	7	20	€ 0,8114
M730900600000	TC	15	30	7	20	€ 0,8114
M730900637000	TC	15	32	7	20	€ 0,8758
M730000637000	SC	15	32	7	20	€ 0,8758
M730000667000	SC	15	35	7	20	€ 0,8758
M730900630000	TC	15	35	7	20	€ 0,8758
M730000661000	SC	15	40	10	20	€ 1,0368
M730000664010	SC	15	42	7	20	€ 1,1656
M730900673000	TC	15,6	25,5	7	20	€ 0,8114
M730000676000	SC	16	22	4	20	€ 0,8436

ANELLI DI TENUTA (PARAOLIO) OIL SEALS



Codice Code	Tipo Type	Dimensioni Dimensions			Q.tà Q.ty	Prezzo Unit Price
M730000690005	SC	16	24	5	20	€ 0,8436
M730900697000	TC	16	26	6	20	€ 0,8114
M730000697100	SC	16	26	7	20	€ 0,8114
M730900700005	SC	16	28	7	20	€ 0,8114
M730900730000	TC	16	30	7	20	€ 0,8114
M730000749900	SC	16	35	7	20	€ 0,8758
M730000760000	SC	16	40	10	20	€ 1,0368
M730000770010	SC	17	25	4	20	€ 0,8436
M730900775000	TC	17	27	5	20	€ 0,8114
M730000776000	SC	17	28	5	20	€ 0,8114
M730000790010	SC	17	28	7	20	€ 0,8114
M730900790020	TC	17	28	7	20	€ 0,8114
M730900793000	TC	17	30	5	20	€ 0,8114
M730900793900	TC	17	30	6	20	€ 0,8114
M730000793010	SC	17	30	7	20	€ 0,8114
M730900800000	TC	17	30	7	20	€ 0,8114
M730000801000	SC	17	32	5	20	€ 0,8758
M730000810005	SC	17	32	7	20	€ 0,8758
M730900810800	TC	17	32	8	20	€ 0,8758
M730000816000	SC	17	35	5	20	€ 0,8758
M730000820005	SC	17	35	7	20	€ 0,8758
M730900820000	TC	17	35	7	20	€ 0,8758
M730000842005	SC	17	40	7	20	€ 1,0368
M730900842000	TC	17	40	7	20	€ 1,0368
M730000845000	SC	17	40	8,5	20	€ 1,0368
M730000850000	SC	17	40	10	20	€ 1,0368
M730000860000	SC	17	47	7	20	€ 1,2622
M730900865000	TC	17	47	8	20	€ 1,2622
M730000863500	SC	17,46	28,58	6,35	20	€ 0,8114
M730000890000	SC	18	28	7	20	€ 0,8114
M730900890000	TC	18	28	7	20	€ 0,8117
M730000895000	SC	18	30	7	20	€ 0,8114
M730900900000	TC	18	32	7	20	€ 0,8758
M730000922000	SC	18	40	7	20	€ 1,0368
M730900922000	TC	18	40	7	20	€ 1,0368
M730000923000	SC	18	40	10	20	€ 1,0368

Codice Code	Tipo Type	Dimensioni Dimensions			Q.tà Q.ty	Prezzo Unit Price
M730000925005	SC	19	27	6	20	€ 0,8114
M730000930010	SC	19	32	7	20	€ 0,8758
M730000940100	SC	19,05	34,93	6,35	20	€ 0,8758
M730000925600	SC	19,08	28,58	6,4	20	€ 0,8114
M730900980000	TC	20	28	4	20	€ 0,8114
M730000990005	SC	20	28	6	20	€ 0,8114
M730001000001	SC	20	30	5	20	€ 0,8114
M730901000000	TC	20	30	5	20	€ 0,8114
M730001020000	SC	20	30	7	20	€ 0,8114
M730901020010	TC	20	30	7	20	€ 0,8114
M730901025000	TC	20	31	7	20	€ 0,8758
M730001030005	SC	20	32	7	20	€ 0,8758
M730901030020	TC	20	32	7	20	€ 0,8758
M730001049700	SC	20	35	5,3	20	€ 0,8758
M730001060000	SC	20	35	6	20	€ 0,8758
M730901070000	SC	20	35	7	20	€ 0,8758
M730001070000	TC	20	35	7	20	€ 0,8758
M730901090000	TC	20	35	10	20	€ 0,8758
M730901093000	TC	20	38	7	20	€ 1,0368
M730901110000	TC	20	40	6	20	€ 1,0368
M733601120010	SC	20	40	7	20	€ 1,0368
M730901120010	TC	20	40	7	20	€ 1,0368
M730901140000	TC	20	40	10	20	€ 1,0368
M730001160000	SC	20	42	7	20	€ 1,1656
M730901160000	TC	20	42	7	20	€ 1,1656
M730001185010	SC	20	47	7	20	€ 1,2622
M730901185005	TC	20	47	7	20	€ 1,2622
M730901210000	TC	20	52	8	10	€ 1,4104
M730001220000	SC	20	52	10	10	€ 1,4104
M730001259900	SC	22	32	5	20	€ 0,8758
M730001270005	SC	22	32	7	20	€ 0,8758
M730901270000	TC	22	32	7	20	€ 0,8758
M730901281500	TC	22	34	7	20	€ 0,8758
M730001283000	SC	22	35	5	20	€ 0,8758
M730001290005	SC	22	35	7	20	€ 0,8758
M730001320000	SC	22	40	7	20	€ 1,0368

ANELLI DI TENUTA (PARAOLIO) OIL SEALS



Codice Code	Tipo Type	Dimensioni Dimensions			Q.tà Q.ty	Prezzo Unit Price
M730001346000	SC	22	42	7	20	€ 1,1656
M730001349900	SC	22	42	10	20	€ 1,1656
M730001356005	SC	22	47	7	20	€ 1,2622
M730001460005	SC	24	35	7	20	€ 0,8758
M730901465000	TC	24	37	5	20	€ 1,0368
M730901480000	TC	24	40	7	20	€ 1,0368
M730001515000	SC	24	47	10	20	€ 1,2622
M730001530000	SC	24	52	10	10	€ 1,4104
M730001580011	SC	25	35	7	20	€ 0,8758
M730901580100	TC	25	35	7	20	€ 0,8758
M730001600005	SC	25	37	5	20	€ 1,0368
M730001610000	SC	25	37	7	20	€ 1,0368
M730001625005	SC	25	38	7	20	€ 1,0368
M730901625005	TC	25	38	7	20	€ 1,0368
M730001627000	SC	25	40	5	20	€ 1,0368
M730001630005	SC	25	40	7	20	€ 1,0368
M730901640000	TC	25	40	7	20	€ 1,0368
M730001660005	SC	25	42	6	20	€ 1,1656
M730001670000	SC	25	42	7	20	€ 1,1656
M730901670010	TC	25	42	7	20	€ 1,1656
M730001680000	SC	25	42	8,5	20	€ 1,1656
M730001688000	SC	25	42	10	20	€ 1,1656
M730001690900	SC	25	43	9	20	€ 1,1656
M730001697000	SC	25	45	7	20	€ 1,1656
M730001710000	SC	25	45	10	20	€ 1,1656
M730901800000	TC	25	46	7	20	€ 1,2622
M730001810000	SC	25	47	7	20	€ 1,2622
M730901810005	TC	25	47	7	20	€ 1,2622
M730001840000	SC	25	47	10	20	€ 1,2622
M730001901000	SC	25	50	10	20	€ 1,2622
M730001880005	SC	25	52	7	10	€ 1,4104
M730901880000	TC	25	52	7	10	€ 1,4104
M730001890000	SC	25	52	8	10	€ 1,4104
M730901890000	TC	25	52	8	10	€ 1,4104
M730001910000	SC	25	52	10	10	€ 1,4104
M730001900000	SC	25	62	10	10	€ 1,7259
M730901900000	TC	25	62	10	10	€ 1,7259

ANELLI DI TENUTA (PARAOLIO)
OIL SEALS



Codice Code	Tipo Type	Dimensioni Dimensions			Q.tà Q.ty	Prezzo Unit Price
M730001936000	SC	26	37	7	20	€ 1,0368
M730901937000	SC	26	37	10	20	€ 1,0368
M730901970000	TC	26	47	7	20	€ 1,2622
M730001980000	SC	26	47	10	20	€ 1,2622
M730002000020	TC	27	37	7	20	€ 1,0368
M730002000000	SC	27	37	7	20	€ 1,0368
M731502003000	TC	27	40	6	20	€ 1,0368
M730002005005	SC	27	42	10	20	€ 1,1656
M730002010000	SC	27	47	6	20	€ 1,2622
M730002015300	SC	27	53	7	10	€ 1,4104
M730002030005	SC	28	38	7	20	€ 1,0368
M730902030000	TC	28	38	7	20	€ 1,0368
M730002045005	SC	28	40	7	20	€ 1,0368
M730902060000	TC	28	42	7	20	€ 1,1656
M730902086100	TC	28	47	7	20	€ 1,2622
M730002130000	SC	28	52	7	10	€ 1,4104
M730002140005	SC	28	52	10	10	€ 1,4104
M730002175000	SC	29	50	10	20	€ 1,2622
M730002180005	SC	30	40	7	20	€ 1,0368
M730902180010	TC	30	40	7	20	€ 1,0368
M730002190005	SC	30	42	7	20	€ 1,1656
M730902190005	TC	30	42	7	20	€ 1,1656
M730902231005	TC	30	44	7	20	€ 1,1656
M730022400000	TC	30	45	8	20	€ 1,1656
M730002250010	SC	30	47	6	20	€ 1,2622
M730902250010	TC	30	47	6	20	€ 1,2622
M730002260000	SC	30	47	7	20	€ 1,2622
M730902260005	TC	30	47	7	20	€ 1,2622
M730002280000	SC	30	47	10	20	€ 1,2622
M730002300000	SC	30	50	5	20	€ 1,2622
M730002310000	SC	30	50	7	20	€ 1,2622
M730002325000	SC	30	50	8	20	€ 1,2622
M730002340000	SC	30	52	7	10	€ 1,4104
M730902340000	TC	30	52	7	10	€ 1,4104
M730002350000	SC	30	52	10	10	€ 1,4104
M730002390000	SC	30	55	7	10	€ 1,4104
M730902390000	TC	30	55	7	10	€ 1,4104

ANELLI DI TENUTA (PARAOLIO) OIL SEALS



Codice Code	Tipo Type	Dimensioni Dimensions			Q.tà Q.ty	Prezzo Unit Price
M730002400000	SC	30	55	10	10	€ 1,4104
M730002420000	SC	30	62	7	10	€ 1,7259
M730902420100	TC	30	62	7	10	€ 1,7259
M730002430001	SC	30	62	10	10	€ 1,7259
M730902430000	TC	30	62	10	10	€ 1,7259
M730002470000	SC	30	72	10	10	€ 2,0093
M730002550005	SC	32	42	7	20	€ 1,1656
M730002565005	SC	32	47	7	20	€ 1,2622
M730902566000	TC	32	47	8	20	€ 1,2622
M730002600000	SC	32	52	7	10	€ 1,4104
M730902605000	TC	32	52	10	10	€ 1,4104
M730002630000	SC	32	62	10	10	€ 1,7259
M730002635500	SC	33	52	6	10	€ 1,4104
M730002706000	SC	34	62	10	10	€ 1,7259
M730002750000	SC	35	45	7	20	€ 1,1656
M730902750000	TC	35	45	7	20	€ 1,1656
M730002760010	SC	35	47	7	20	€ 1,2622
M730902760002	TC	35	47	7	20	€ 1,2622
M730002824500	SC	35	50	7	20	€ 1,2622
M730902830000	TC	35	50	8	20	€ 1,2622
M730002850010	SC	35	52	7	10	€ 1,4104
M730902850000	TC	35	52	7	10	€ 1,4104
M730902870000	TC	35	52	10	10	€ 1,4104
M730002871000	SC	35	52	10	10	€ 1,4104
M730002890000	SC	35	55	8	10	€ 1,4104
M730002910000	SC	35	55	10	10	€ 1,4104
M730902910000	TC	35	55	10	10	€ 1,4104
M730002920000	SC	35	56	10	10	€ 1,6100
M730902920000	TC	35	56	10	10	€ 1,6100
M730002940000	SC	35	60	10	10	€ 1,6100
M730002950000	SC	35	62	7	10	€ 1,7259
M730902950000	TC	35	62	7	10	€ 1,7259
M730002970005	SC	35	62	10	10	€ 1,7259
M730902970000	TC	35	62	10	10	€ 1,7259
M730003010000	SC	35	65	10	10	€ 1,7259
M730003044000	SC	35	72	10	10	€ 2,0093
M730903044000	TC	35	72	10	10	€ 2,0093

ANELLI DI TENUTA (PARAOLIO)
OIL SEALS



Codice Code	Tipo Type	Dimensioni Dimensions			Q.tà Q.ty	Prezzo Unit Price
M730903058000	TC	35	80	10	10	€ 2,1703
M730003075000	SC	36	50	7	20	€ 1,2622
M730003076000	SC	36	52	7	10	€ 1,4104
M730903087000	TC	36	58	12	10	€ 1,6100
M730003092010	SC	36	62	7	10	€ 1,7259
M730003130005	SC	38	50	7	20	€ 1,2622
M730903132000	TC	38	52	7	10	€ 1,4104
M730003133000	SC	38	52	8	10	€ 1,4104
M730003152000	SC	38	55	7	10	€ 1,4104
M730903156005	TC	38	58	7	10	€ 1,6100
M730003170000	SC	38	62	10	10	€ 1,7259
M730003190000	SC	40	52	7	10	€ 1,4104
M730903190000	TC	40	52	7	10	€ 1,4104
M730903198000	TC	40	52	8,5	10	€ 1,4104
M730903200000	TC	40	55	7	10	€ 1,4104
M730903201000	TC	40	55	8	10	€ 1,4104
M730003220010	SC	40	56	8	10	€ 1,6100
M730903220000	TC	40	56	8	10	€ 1,6100
M730903243100	TC	40	58	10	10	€ 1,6100
M730003245000	SC	40	60	10	10	€ 1,6100
M730903245000	TC	40	60	10	10	€ 1,6100
M730903262000	TC	40	62	8	10	€ 1,7259
M730903263500	TC	40	62	10	10	€ 1,7259
M730903266000	TC	40	65	10	10	€ 1,7259
M730003270000	SC	40	68	10	10	€ 1,8483
M730903270000	TC	40	68	10	10	€ 1,8483
M730003271000	SC	40	72	7	10	€ 2,0093
M730003280000	SC	40	72	10	10	€ 2,0093
M730903280000	TC	40	72	10	10	€ 2,0093
M730003282000	SC	40	80	10	10	€ 2,1703
M730903282000	TC	40	80	10	10	€ 2,1703
M730903285000	TC	40	80	12	10	€ 2,1703
M730903305000	TC	42	55	8	10	€ 1,4104
M730003320000	SC	42	56	7	10	€ 1,6100
M730903330000	TC	42	58	8	10	€ 1,6100
M730003350000	SC	42	60	10	10	€ 1,6100
M730003355000	SC	42	62	8	10	€ 1,7259

ANELLI DI TENUTA (PARAOLIO) OIL SEALS



Codice Code	Tipo Type	Dimensioni Dimensions			Q.tà Q.ty	Prezzo Unit Price
M730903355000	TC	42	62	8	10	€ 1,7259
M730903365000	TC	42	62	10	10	€ 1,7259
M730003375000	SC	42	72	8	10	€ 2,0093
M730903400000	TC	45	58	7	10	€ 1,6100
M730003420005	SC	45	60	7	10	€ 1,6100
M730903420000	TC	45	60	7	10	€ 1,6100
M730003422000	SC	45	60	10	10	€ 1,6100
M730003426000	SC	45	62	8	10	€ 1,7259
M730903426005	TC	45	62	8	10	€ 1,7259
M730003428005	SC	45	62	10	10	€ 1,7259
M730003450000	SC	45	65	8	10	€ 1,7259
M730903452000	TC	45	65	10	10	€ 1,7259
M730003452200	SC	45	68	10	10	€ 1,8483
M730003455000	SC	45	72	8	10	€ 2,0093
M730903455000	TC	45	72	8	10	€ 2,0093
M730003457000	SC	45	72	10	10	€ 2,0093
M730903462000	TC	45	75	10	10	€ 2,0093
M730003470005	SC	45	80	10	10	€ 2,1703
M730903470000	TC	45	80	10	10	€ 2,1703
M730003475000	SC	45	85	10	10	€ 2,3506
M730003491000	SC	48	62	8	10	€ 1,7259
M730003492000	SC	48	62	10	10	€ 1,7259
M730903492000	TC	48	62	10	10	€ 1,7259
M730003501000	SC	48	80	10	10	€ 2,1703
M730003508000	SC	50	62	10	10	€ 1,7259
M730903510000	TC	50	65	8	10	€ 1,7259
M730903513000	TC	50	68	8	10	€ 1,8483
M730903514000	TC	50	68	10	10	€ 1,8483
M730003520000	SC	50	70	10	10	€ 1,8483
M730903520000	TC	50	70	10	10	€ 1,8483
M730003522000	SC	50	72	8	10	€ 2,0093
M730903522000	TC	50	72	8	10	€ 2,0093
M730903525000	TC	50	72	10	10	€ 2,0093
M730003527000	SC	50	80	8	10	€ 2,1703
M730903527000	TC	50	80	8	10	€ 2,1703
M730903528000	TC	50	80	10	10	€ 2,1703
M730903533000	TC	50	90	10	10	€ 2,5374
M730003546500	SC	52	68	10	10	€ 1,8483
M730903548000	TC	52	72	10	10	€ 2,0093
M730003549000	SC	52	80	10	10	€ 2,1703
M730003550000	SC	52	85	10	10	€ 2,3506
M730903550000	TC	52	85	10	10	€ 2,3506

ANELLI DI TENUTA (PARAOLIO)
OIL SEALS



Codice Code	Tipo Type	Dimensioni Dimensions			Q.tà Q.ty	Prezzo Unit Price
M730003561000	SC	55	68	8	10	€ 1,8483
M730903568000	TC	55	70	8	10	€ 1,8483
M730903569000	TC	55	70	10	10	€ 1,8483
M730903569100	TC	55	72	8	10	€ 2,0093
M730903570000	TC	55	72	10	10	€ 2,0093
M730003574000	SC	55	75	10	10	€ 2,0093
M730903574000	TC	55	75	10	10	€ 2,0093
M730903578000	TC	55	80	8	10	€ 2,1703
M730003580000	SC	55	80	10	10	€ 2,1703
M730003585000	SC	55	85	8	10	€ 2,3506
M730003586000	SC	55	85	10	10	€ 2,3506
M730903586000	TC	55	85	10	10	€ 2,3506
M730003590000	SC	55	90	10	10	€ 2,5374
M730903590000	TC	55	90	10	10	€ 2,5374
M730903597000	TC	55	100	10	Free	€ 3,2007
M730900360100	TC	58	72	10	10	€ 2,0093
M730903605200	TC	58	80	12	10	€ 2,1703
M730003611000	SC	60	75	8	10	€ 2,0093
M730903611000	TC	60	75	8	10	€ 2,0093
M730003614000	SC	60	80	8	10	€ 2,1703
M730903615004	TC	60	80	10	10	€ 2,1703
M730903620000	TC	60	85	8	10	€ 2,3506
M730003625000	SC	60	85	10	10	€ 2,3506
M730903625000	TC	60	85	10	10	€ 2,3506
M730903628000	TC	60	90	10	10	€ 2,5374
M730003629000	SC	60	95	10	Free	€ 2,9173
M730903629000	TC	60	95	10	Free	€ 2,9173
M730003629500	SC	60	100	10	Free	€ 3,2007
M730003634000	SC	62	85	10	10	€ 2,3506
M730903634000	TC	62	85	10	10	€ 2,3506
M730003636005	SC	62	90	10	10	€ 2,5374
M730903638000	TC	63	90	10	10	€ 2,5374
M730003640000	SC	64	80	8	10	€ 2,1703
M730903637800	TC	65	75	8	10	€ 2,0093
M730903649005	TC	65	85	10	10	€ 2,3506
M730903651000	TC	65	90	10	10	€ 2,5374
M730003654000	SC	65	100	10	Free	€ 3,2007
M730903654000	TC	65	100	10	Free	€ 3,2007
M730903656000	TC	68	90	7	10	€ 2,5374
M730003656000	SC	68	90	7	10	€ 2,5374
M730903660000	TC	68	90	10	10	€ 2,5374
M730903668000	TC	70	85	8	10	€ 2,3506

ANELLI DI TENUTA (PARAOLIO) OIL SEALS



Codice Code	Tipo Type	Dimensioni Dimensions			Q.tà Q.ty	Prezzo Unit Price
M730003670000	SC	70	90	10	10	€ 2,5374
M730903670000	TC	70	90	10	10	€ 2,5374
M730003760000	SC	70	100	10	Free	€ 3,2007
M730903760000	TC	70	100	10	Free	€ 3,2007
M730003680000	SC	70	110	8	Free	€ 3,9606
M730003685000	SC	70	110	12	Free	€ 3,9606
M730903687000	TC	70	110	13	Free	€ 3,9606
M730003690000	SC	72	90	10	10	€ 2,5374
M730003694500	SC	75	95	10	Free	€ 2,9173
M730003698000	SC	75	95	12	Free	€ 2,9173
M730003699000	SC	75	100	10	Free	€ 3,2007
M730903699000	TC	75	100	10	Free	€ 3,2007
M730003705000	SC	75	110	12	Free	€ 3,9606
M730903706000	TC	75	120	10	Free	€ 4,6239
M730003717000	SC	80	100	10	Free	€ 3,2007
M730003745900	SC	85	110	10	Free	€ 3,9606
M730903745900	TC	80	110	10	Free	€ 3,9606
M730903744900	TC	85	105	10	Free	€ 3,6193
M730903759900	TC	85	110	13	Free	€ 3,9606
M730903755000	TC	85	120	13	Free	€ 4,6239
M730903761000	TC	85	130	10	Free	€ 5,4096
M730903772000	TC	90	110	12	Free	€ 3,9606
M730903782000	TC	90	120	12	Free	€ 4,6239
M730903788000	TC	95	115	12	Free	€ 4,2890
M730003790000	SC	95	120	12	Free	€ 4,6239
M730003795000	SC	95	125	12	Free	€ 4,9524
M730903799000	TC	95	130	8	Free	€ 5,4096
M730903805000	TC	100	120	12	Free	€ 4,6239
M730003805000	SC	100	120	12	Free	€ 4,6239
M730003810000	SC	100	125	12	Free	€ 4,9524
M730903815000	TC	100	130	12	Free	€ 5,4096
M730003817000	SC	100	140	12	Free	€ 6,0858
M730003824000	SC	105	130	13	Free	€ 5,4096
M730903830000	TC	110	130	12	Free	€ 5,4096
M730003838000	SC	110	140	12	Free	€ 6,0858
M730003842000	SC	110	150	13	Free	€ 6,4142
M730003872000	SC	120	160	13	Free	€ 7,6314
M730003890000	SC	130	160	12	Free	€ 7,6314
M730903890000	TC	130	160	12	Free	€ 7,6314

COPERCHI DI CHIUSURA COVER SEALS

Il coperchio di chiusura è il sistema più semplice ed economico per chiudere ermeticamente un foro. Sono costruiti con un'armatura metallica ricoperta esternamente da gomma nitrilica NBR tipo a 727.

The cover seal is the easiest and cheapest way to seal a hole. They are built with a metal frame covered externally by nitrile rubber NBR type 727.



COPERCHI DI CHIUSURA
COVER SEALS



Codice Code	Tipo Type	Ø D mm	H mm	Q.tà Q.ty	Prezzo Unit Price
S739901907010	RCA 19-7	19	7	20	€ 1,7640
S739902204010	RCA 22-4	22	4	20	€ 1,7640
S739902607010	RCA 26-7	26	7	20	€ 1,7640
S739902804010	RCA 28-4	28	4	20	€ 1,8690
S739902807010	RCA 28-7	28	7	20	€ 1,8690
S739903005010	RCA 30-5	30	5	20	€ 1,8690
S739903207010	RCA 32-7	30	7	20	€ 1,9635
S739903505010	RCA 35-5	35	5	20	€ 2,0790
S739903507010	RCA 35-7	35	7	20	€ 2,0790
S739903705010	RCA 37-5	37	5	20	€ 2,0790
S739903707010	RCA 37-7	37	7	20	€ 2,3100
S739904007010	RCA 40-7	40	7	20	€ 2,3100
S739904207010	RCA 42-7	42	7	20	€ 2,3100
S739904507010	RCA 45-7	45	7	20	€ 2,4255
S739904707010	RCA 47-7	47	7	20	€ 2,4255
S739905207010	RCA 52-7	52	7	20	€ 2,5200
S739906207010	RCA 62-7	62	7	20	€ 2,7405
S739906201010	RCA 62-10	62	10	20	€ 2,7405
S739907201010	RCA 72-10	72	10	20	€ 3,9480
S739908001010	RCA 80-10	80	10	20	€ 4,4940
S739908501010	RCA 85-10	85	10	20	€ 4,9350
S739909001010	RCA 90-10	90	10	20	€ 5,4810
S739901001010	RCA 100-10	100	10	FREE	€ 6,3525
S739901101010	RCA 110-10	110	10	FREE	€ 7,0140



ANTIVIBRANTI VIBRATION DAMPINGS



QTY	REJECT QTY	% OF PJ	REMARKS
AS			
DATE			
FREQ DATE			
STEP 1			

SUPPORTI ANTIVIBRANTI VIBRATION DAMPINGS

Le vibrazioni e i rumori prodotti dai macchinari si propagano attraverso le strutture collegate e influenzano molto spesso il buon funzionamento delle apparecchiature adiacenti. Gli antivibranti da noi prodotti sono ricavati dalla combinazione di gomma naturale o sintetica, vulcanizzata su acciaio zincato e sono la soluzione migliore per la riduzione delle vibrazioni e del rumore.

Vibrations and noises produced by machineries diffused through connected equipments often affect the proper functioning of the nearby devices. Our vibration dampings are made from a combination of natural or synthetic rubber, cured on galvanized steel and they're the best solution to reduce vibrations and noises.



SUPPORTI ANTIVIBRANTI VIBRATION DAMPINGS

Antivibranti cilindrici serie MM con vite da entrambe le parti
Cylindrical vibration dampings type MM with screw bolt on both sides

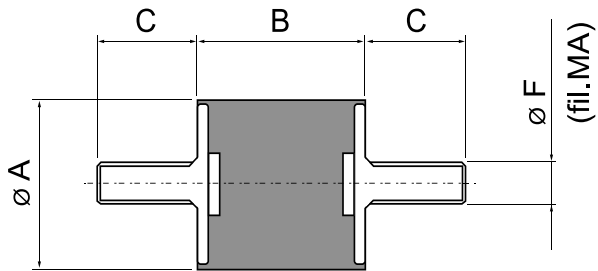

Antivibranti sgolati serie MM con vite da entrambe le parti
Concave vibration dampings type MM with screw bolt on both side

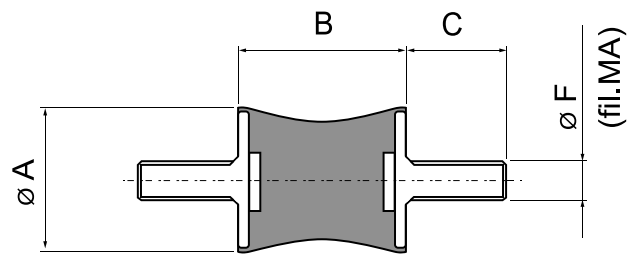

Antivibranti cilindrici serie MF con vite da una parte e foro filettato dall'altra
Cylindrical vibration dampings type MF with screw bolt one side and threaded hole on the other one

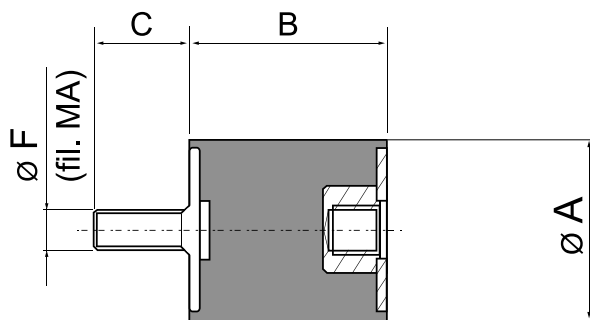

Antivibranti sgolati serie MF con vite da una parte e foro filettato dall'altra
Concave vibration dampings type MF with screw bolt one side and threaded hole on the other one

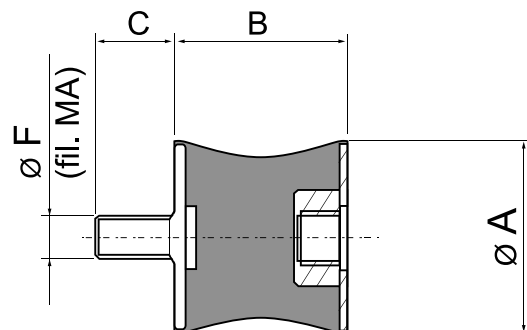

Antivibranti cilindrici serie FF con foro filettato da entrambe le parti
Cylindrical vibration dampings type FF with threaded hole on both sides

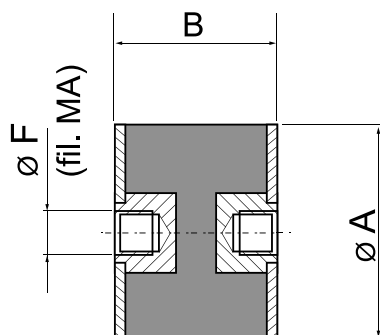

Antivibranti sgolati serie FF con foro filettato da entrambe le parti
Concave vibration dampings type FF with threaded hole on both sides

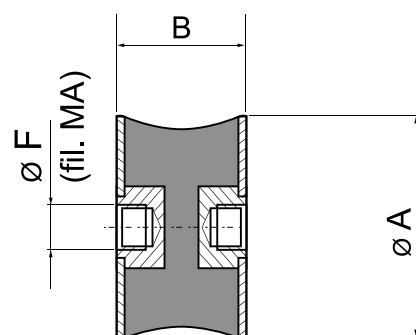

SUPPORTI ANTIVIBRANTI
VIBRATION DAMPINGS

Antivibranti cilindrici serie PF con foro filettato superiore
Cylindrical vibration dampings type PF with upper threaded hole

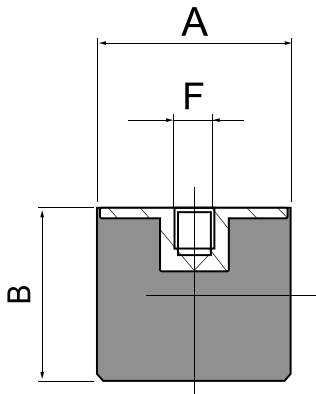

Antivibranti cilindrici serie PM con vite superiore
Concave vibration dampings type PM with upper screw bolt

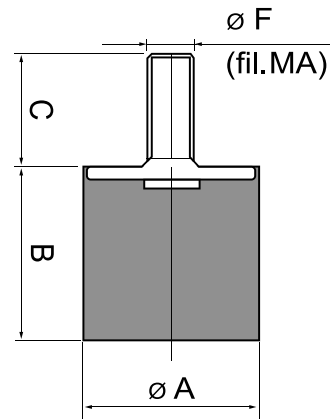

Antivibranti troncoconici serie TC versione PM con vite superiore
Truncated cone-shaped vibration dampings model TC type PM with upper screw bolt

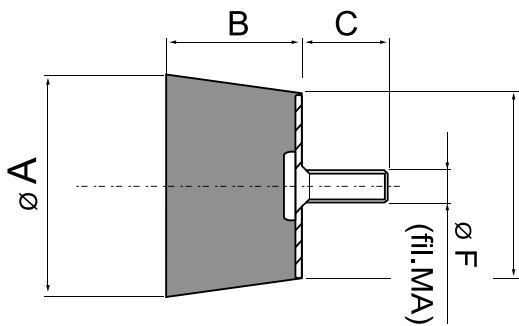

Antivibranti paracolpi a parabola serie PC versione PM con vite superiore
Cone-shaped vibration dampings model PC type PM with upper screw bolt

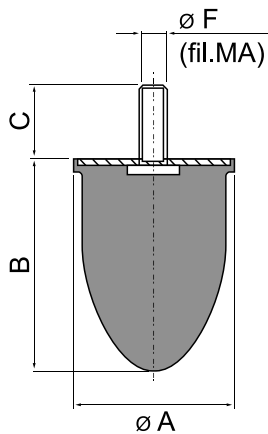

Antivibranti paracolpi troncoconici serie PTC versione PM con vite superiore
Truncated cone-shaped vibration dampings model PTC type PM with upper screw bolt

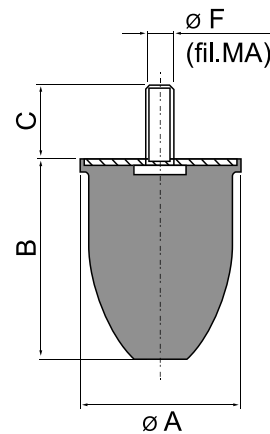

SUPPORTI ANTIVIBRANTI VIBRATION DAMPINGS



Codice Code	Descrizione Description	FIX	ØA	B	ØF	C	Q.tà Q.ty	Prezzo Unit Price
1015A512A51260	ANT. CILINDRICO 10/15	MM	10	15	5	10	50	€ 0,8012
1015A512B560	ANT. CILINDRICO 10/15	MF	10	15	5	10	50	€ 0,7833
1015B5B560	ANT. CILINDRICO 10/15	FF	10	15	5	-	50	€ 0,8484
1515A412A41260	ANT. CILINDRICO 15/15	MM	15	15	4	10	50	€ 0,7581
1515A412B460	ANT. CILINDRICO 15/15	MF	15	15	4	10	50	€ 0,6038
1515A512A51260	ANT. CILINDRICO 15/15	MM	15	15	5	10	50	€ 0,8505
1515A512B560	ANT. CILINDRICO 15/15	MF	15	15	5	10	50	€ 0,7004
1515B4B460	ANT. CILINDRICO 15/15	FF	15	15	4	-	50	€ 0,6038
1515B5B560	ANT. CILINDRICO 15/15	FF	15	15	5	-	50	€ 0,5429
1520A512A51260	ANT. CILINDRICO 15/20	MM	15	20	5	10	50	€ 0,7949
1520A512B560	ANT. CILINDRICO 15/20	MF	15	20	5	10	50	€ 0,6962
1520B5B560	ANT. CILINDRICO 15/20	FF	15	20	5	-	50	€ 0,6783
2010A614A61460	ANT. CILINDRICO 20/10	MM	20	10	6	12	25	€ 0,7214
2010A614B660	ANT. CILINDRICO 20/10	MF	20	10	6	12	25	€ 0,8159
2010DA61660	ANT. CILINDRICO 20/10	PM	20	10	6	14	25	€ 0,8138
2015A616A61660	ANT. CILINDRICO 20/15	MM	20	15	6	14	25	€ 0,8936
2015A616B660	ANT. CILINDRICO 20/15	MF	20	15	6	14	25	€ 0,7518
2015B6B660	ANT. CILINDRICO 20/15	FF	20	15	6	-	25	€ 0,6531
2015DA61660	ANT. CILINDRICO 20/15	PM	20	15	6	14	25	€ 0,7340
2020A616A61660	ANT. CILINDRICO 20/20	MM	20	20	6	14	25	€ 0,9923
2020A616B660	ANT. CILINDRICO 20/20	MF	20	20	6	14	25	€ 0,8694
2020B6B660	ANT. CILINDRICO 20/20	FF	20	20	6	-	25	€ 0,8264
2025A516A51660	ANT. CILINDRICO 20/25	MM	20	25	5	14	25	€ 1,2327
2025A516B560	ANT. CILINDRICO 20/25	MF	20	25	5	14	25	€ 1,0962
2025A616A61660	ANT. CILINDRICO 20/25	MM	20	25	6	14	25	€ 0,8631
2025A616B660	ANT. CILINDRICO 20/25	MF	20	25	6	14	25	€ 0,8505
2025B6B660	ANT. CILINDRICO 20/25	FF	20	25	6	-	25	€ 0,8936
2030A616A61660	ANT. CILINDRICO 20/30	MM	20	30	6	14	25	€ 1,1088
2030A616B660	ANT. CILINDRICO 20/30	MF	20	30	6	14	25	€ 1,1088
2030B6B660	ANT. CILINDRICO 20/30	FF	20	30	6	-	25	€ 0,9125
2500A616A61660	ANT. SGOLATO 25/20/10	MM	25	10	6	14	25	€ 1,2327
2515A616A61660	ANT. CILINDRICO 25/15	MM	25	15	6	14	25	€ 1,1771
2515A616B660	ANT. CILINDRICO 25/15	MF	25	15	6	14	25	€ 1,1277
2515B6B660	ANT. CILINDRICO 25/15	FF	25	15	6	-	25	€ 0,8694
2515DA61660	ANT. CILINDRICO 25/15	PM	25	15	6	14	25	€ 0,6783
2520A620A62060	ANT. CILINDRICO 25/20	MM	25	20	6	18	25	€ 1,1708
2520A620B660	ANT. CILINDRICO 25/20	MF	25	20	6	18	25	€ 1,2138
2520A820A82060	ANT. CILINDRICO 25/20	MM	25	20	8	18	25	€ 1,2695
2520A820B860	ANT. CILINDRICO 25/20	MF	25	20	8	18	25	€ 1,4049
2520B6B660	ANT. CILINDRICO 25/20	FF	25	20	6	-	25	€ 1,1088

SUPPORTI ANTIVIBRANTI
VIBRATION DAMPINGS

Codice Code	Descrizione Description	FIX	ØA	B	ØF	C	Q.tà Q.ty	Prezzo Unit Price
2520B8B860	ANT. CILINDRICO 25/20	FF	25	20	8	-	25	€ 1,0479
2520DA62060	ANT. CILINDRICO 25/20	PM	25	20	6	18	25	€ 0,9618
2520DA82060	ANT. CILINDRICO 25/20	PM	25	20	8	18	25	€ 0,9860
2525A620A62060	ANT. CILINDRICO 25/25	MM	25	25	6	18	25	€ 1,4049
2525A620B660	ANT. CILINDRICO 25/25	MF	25	25	6	18	25	€ 1,3314
2525B6B660	ANT. CILINDRICO 25/25	FF	25	25	6	-	25	€ 1,2012
2530A620A62060	ANT. CILINDRICO 25/30	MM	25	30	6	18	25	€ 1,6244
2530A620B660	ANT. CILINDRICO 25/30	MF	25	30	6	18	25	€ 1,5992
2530B6B660	ANT. CILINDRICO 25/30	FF	25	30	6	-	25	€ 1,4490
2535A620A62060	ANT. CILINDRICO 25/35	MM	25	35	6	18	25	€ 1,7924
2535A620B660	ANT. CILINDRICO 25/35	MF	25	35	6	18	25	€ 1,6412
2535B6B660	ANT. CILINDRICO 25/35	FF	25	35	6	-	25	€ 1,5110
3015A820A82060	ANT. CILINDRICO 30/15	MM	30	15	8	18	25	€ 1,5278
3015A820B860	ANT. CILINDRICO 30/15	MF	30	15	8	18	25	€ 1,4301
3020A825A82560	ANT. CILINDRICO 30/20	MM	30	20	8	23	25	€ 1,6086
3020A825B860	ANT. CILINDRICO 30/20	MF	30	20	8	23	25	€ 1,5897
3020B8B860	ANT. CILINDRICO 30/20	FF	30	20	8	-	25	€ 2,0024
3020DA82560	ANT. CILINDRICO 30/20	PM	30	20	8	23	25	€ 1,0049
3020DB860	ANT. CILINDRICO 30/20	PF	30	20	8	-	25	€ 1,8480
3025A825A82560	ANT. CILINDRICO 30/25	MM	30	25	8	23	25	€ 1,5341
3025A825B860	ANT. CILINDRICO 30/25	MF	30	25	8	23	25	€ 1,6013
3025B8B860	ANT. CILINDRICO 30/25	FF	30	25	8	-	25	€ 2,0024
3030A625A62560	ANT. CILINDRICO 30/30	MM	30	30	6	23	25	€ 1,5099
3030A625B660	ANT. CILINDRICO 30/30	MF	30	30	6	23	25	€ 1,6695
3030A825A82560	ANT. CILINDRICO 30/30	MM	30	30	8	23	25	€ 1,8669
3030A825B860	ANT. CILINDRICO 30/30	MF	30	30	8	23	25	€ 1,8480
3030B6B660	ANT. CILINDRICO 30/30	FF	30	30	6	-	25	€ 2,0328
3030B8B860	ANT. CILINDRICO 30/30	FF	30	30	8	-	25	€ 2,1557
3030DA82560	ANT. CILINDRICO 30/30	PM	30	30	8	23	25	€ 1,4973
304020DA62060	ANT.TRONCO CONICO 30/40/20	PM	30	20	6	18	25	€ 3,4745
304020DB660	ANT.TRONCO CONICO 30/40/20	PF	30	20	6	-	25	€ 1,8155
3040A825A82560	ANT. CILINDRICO 30/40	MM	30	40	8	23	25	€ 2,0948
3040A825B860	ANT. CILINDRICO 30/40	MF	30	40	8	23	25	€ 1,8113
3040B8B860	ANT. CILINDRICO 30/40	FF	30	40	8	-	25	€ 2,8560
3040DA82560	ANT. CILINDRICO 30/40	PM	30	40	8	23	25	€ 1,8113
4015DA82560	ANT. CILINDRICO 40/15	PM	40	15	8	23	15	€ 1,6149
4020A825A82560	ANT. CILINDRICO 40/20	MM	40	20	8	23	15	€ 2,0276
4020A825B860	ANT. CILINDRICO 40/20	MF	40	20	8	23	15	€ 2,1557
4020B8B860	ANT. CILINDRICO 40/20	FF	40	20	8	-	15	€ 2,1809
4020DA82560	ANT. CILINDRICO 40/20	PM	40	20	8	23	15	€ 1,7010

SUPPORTI ANTIVIBRANTI VIBRATION DAMPINGS



Codice Code	Descrizione Description	FIX	ØA	B	ØF	C	Q.tà Q.ty	Prezzo Unit Price
4020DB860	ANT. CILINDRICO 40/20	PF	40	20	8	-	15	€ 1,5771
4030A825A82560	ANT. CILINDRICO 40/30	MM	40	30	8	23	15	€ 2,3048
4030A825B860	ANT. CILINDRICO 40/30	MF	40	30	8	23	15	€ 2,4024
4030AX25AX2560	ANT. CILINDRICO 40/30	MM	40	30	10	23	15	€ 3,0125
4030AX25BX60	ANT. CILINDRICO 40/30	MF	40	30	10	23	15	€ 2,7720
4030B8B860	ANT. CILINDRICO 40/30	FF	40	30	8	-	15	€ 2,7353
4030BXX60	ANT. CILINDRICO 40/30	FF	40	30	10	-	15	€ 2,6555
4030DA82560	ANT. CILINDRICO 40/30	PM	40	30	8	23	15	€ 2,0391
4030DAX2560	ANT. CILINDRICO 40/30	PM	40	30	10	23	15	€ 1,9467
4030DB860	ANT. CILINDRICO 40/30	PF	40	30	8	-	15	€ 1,7682
4030DBX60	ANT. CILINDRICO 40/30	PF	40	30	10	-	15	€ 2,3520
4030PC82560	ANT. PARABOLICO 40/30	PM	40	30	8	23	15	€ 2,0213
4035A825A82560	ANT. CILINDRICO 40/35	MM	40	35	8	23	15	€ 2,8035
4035A825B860	ANT. CILINDRICO 40/35	MF	40	35	8	23	15	€ 2,7416
4035B8B860	ANT. CILINDRICO 40/35	FF	40	35	8	-	15	€ 2,4833
4037A822A82260	ANT. SGOLATO 40/30/27	MM	40-27	30	8	20	15	€ 2,3352
4037A822B860	ANT. SGOLATO 40/30/27	MF	40-27	30	8	20	15	€ 2,2796
4037B8B860	ANT. SGOLATO 40/30/27	FF	40-27	30	8	-	15	€ 2,8004
4039A822A82260	ANT. SGOLATO 40/30/19	MM	40-19	30	8	20	15	€ 2,1693
4040A825A82560	ANT. CILINDRICO 40/40	MM	40	40	8	23	15	€ 2,6744
4040A825B860	ANT. CILINDRICO 40/40	MF	40	40	8	23	15	€ 2,6492
4040B8B860	ANT. CILINDRICO 40/40	FF	40	40	8	23	15	€ 2,9568
405025TC82560	TRONCO CONICO TC 40/50/25	PM	40-50	25	8	23	15	€ 2,4339
405025TC860	TRONCO CONICO TC 40/50/25	PF	40-50	25	8	-	15	€ 2,7972
4060PC82560	ANT. PARABOLICO PC. 40/60	PM	40	60	8	23	15	€ 2,7972
4060PC860	ANT. PARABOLICO PC. 40/60	PF	40	60	8	-	15	€ 3,5847
5020AX25AX2560	ANT. CILINDRICO 50/20	MM	50	20	10	23	1	€ 3,4503
5020AX25BX60	ANT. CILINDRICO 50/20	MF	50	20	10	23	1	€ 3,2288
5020BXX60	ANT. CILINDRICO 50/20	FF	50	20	10	-	1	€ 3,2099
5020DAX2560	ANT. CILINDRICO 50/20	PM	50	20	10	23	1	€ 2,5935
5030AX25AX2560	ANT. CILINDRICO 50/30	MM	50	30	10	23	1	€ 3,1364
5030AX25BX60	ANT. CILINDRICO 50/30	MF	50	30	10	23	1	€ 3,9858
5030BXX60	ANT. CILINDRICO 50/30	FF	50	30	10	-	1	€ 3,6351
5030DAX2560	ANT. CILINDRICO 50/30	PM	50	30	10	23	1	€ 3,2655
5040AX25AX2560	ANT. CILINDRICO 50/40	MM	50	40	10	23	1	€ 4,0226
5040AX25BX60	ANT. CILINDRICO 50/40	MF	50	40	10	23	1	€ 4,2504
5040BXX60	ANT. CILINDRICO 50/40	FF	50	40	10	-	1	€ 4,5035
5040DAX2560	ANT. CILINDRICO 50/40	PM	50	40	10	23	1	€ 3,8871
5045AX25AX2560	ANT. CILINDRICO 50/45	MM	50	45	10	23	1	€ 4,0971
5045AX25BX60	ANT. CILINDRICO 50/45	MF	50	45	10	23	1	€ 4,7807

SUPPORTI ANTIVIBRANTI
VIBRATION DAMPINGS

Codice Code	Descrizione Description	FIX	ØA	B	ØF	C	Q.tà Q.ty	Prezzo Unit Price
5045BxBX60	ANT. CILINDRICO 50/45	FF	50	45	10	-	1	€ 4,1276
5050AX25AX2560	ANT. CILINDRICO 50/50	MM	50	50	10	23	1	€ 4,0971
5050AX25BxBX60	ANT. CILINDRICO 50/50	MF	50	50	10	23	1	€ 5,2364
5050BxBX60	ANT. CILINDRICO 50/50	FF	50	50	10	-	1	€ 5,1566
5050DAX2560	ANT. CILINDRICO 50/50	PM	50	50	10	23	1	€ 4,4730
6030AY35AY3560	ANT. CILINDRICO 60/30	MM	60	30	12	31	1	€ 5,5167
6030AY35BY60	ANT. CILINDRICO 60/30	MF	60	30	12	31	1	€ 5,5556
6030BYBY60	ANT. CILINDRICO 60/30	FF	60	30	12	-	1	€ 5,5556
6030DAY3560	ANT. CILINDRICO 60/30	PM	60	30	12	31	1	€ 4,0583
6035AY35AY3560	ANT. CILINDRICO 60/35	MM	60	35	12	31	1	€ 6,4512
6035AY35BY60	ANT. CILINDRICO 60/35	MF	60	35	12	31	1	€ 5,4768
6035BYBY60	ANT. CILINDRICO 60/40	FF	60	40	12	-	1	€ 5,4180
6040AY35AY3560	ANT. CILINDRICO 60/40	MM	60	40	12	31	1	€ 6,1656
6040AY35BY60	ANT. CILINDRICO 60/40	MF	60	40	12	31	1	€ 6,3567
6040BYBY60	ANT. CILINDRICO 60/40	FF	60	40	12	-	1	€ 5,4716
6040DAY3560	ANT. CILINDRICO 60/40	PM	60	40	12	31	1	€ 5,4107
6045AY35AY3560	ANT. CILINDRICO 60/45	MM	60	45	12	31	1	€ 7,4424
6045AY35BY60	ANT. CILINDRICO 60/45	MF	60	45	12	31	1	€ 6,4512
6045BYBY60	ANT. CILINDRICO 60/45	FF	60	45	12	-	1	€ 6,1289
6045DAY3560	ANT. CILINDRICO 60/45	PM	60	45	12	31	1	€ 5,3319
6050AY35AY3560	ANT. CILINDRICO 60/50	MM	60	50	12	31	1	€ 6,6759
6050AY35BY60	ANT. CILINDRICO 60/50	MF	60	50	12	31	1	€ 6,2276
6050BYBY60	ANT. CILINDRICO 60/50	FF	60	50	12	-	1	€ 6,0092
6050DAY3560	ANT. CILINDRICO 60/50	PM	60	50	12	31	1	€ 6,0480
6055AY35AY3560	ANT. CILINDRICO 60/55	MM	60	55	12	31	1	€ 7,1684
6055AY35BY60	ANT. CILINDRICO 60/55	MF	60	55	12	31	1	€ 6,8880
6055BYBY60	ANT. CILINDRICO 60/55	FF	60	55	12	-	1	€ 6,3620
6060AY35AY3560	ANT. CILINDRICO 60/60	MM	60	60	12	31	1	€ 8,1764
6060AY35BY60	ANT. CILINDRICO 60/60	MF	60	60	12	31	1	€ 7,9191
6060BYBY60	ANT. CILINDRICO 60/60	FF	60	60	12	-	1	€ 7,0004
6060PCY3560	ANT.PARABOLICO PC 60/60	PM	60	60	12	31	1	€ 6,1604
6060PCY60	ANT.PARABOLICO PC 60/60	PF	60	60	12	-	1	€ 6,1604
7525AY50AY5060	ANT. CILINDRICO 75/25	MM	75	25	12	47	1	€ 9,2684
7525AY50BY60	ANT. CILINDRICO 75/25	MF	75	25	12	47	1	€ 8,1144
7525BYBY60	ANT. CILINDRICO 75/25	FF	75	25	12	-	1	€ 7,2807
7525DAY5060	ANT. CILINDRICO 75/25	PM	75	25	12	47	1	€ 6,9216
7530AY50AY5060	ANT. CILINDRICO 75/30	MM	75	30	12	47	1	€ 8,0966
7530AY50BY60	ANT. CILINDRICO 75/30	MF	75	30	12	47	1	€ 7,8015
7530BYBY60	ANT. CILINDRICO 75/30	FF	75	30	12	-	1	€ 7,8404
7530DAY5060	ANT. CILINDRICO 75/30	PM	75	30	12	47	1	€ 7,2408

SUPPORTI ANTIVIBRANTI VIBRATION DAMPINGS



Codice Code	Descrizione Description	FIX	ØA	B	ØF	C	Q.tà Q.ty	Prezzo Unit Price
7535AY50AY5060	ANT. CILINDRICO 75/35	MM	75	35	12	47	1	€ 8,7906
7535AY50BY60	ANT. CILINDRICO 75/35	MF	75	35	12	47	1	€ 8,5617
7535BYBY60	ANT. CILINDRICO 75/35	FF	75	35	12	-	1	€ 8,3444
7540AY50AY5060	ANT. CILINDRICO 75/40	MM	75	40	12	47	1	€ 10,5840
7540AY50BY60	ANT. CILINDRICO 75/40	MF	75	40	12	47	1	€ 11,0324
7540BYBY60	ANT. CILINDRICO 75/40	FF	75	40	12	-	1	€ 10,4895
7540DAY5060	ANT. CILINDRICO 75/40	PM	75	40	12	47	1	€ 8,7360
7550AY50AY5060	ANT. CILINDRICO 75/50	MM	75	50	12	47	1	€ 11,3684
7550AY50BY60	ANT. CILINDRICO 75/50	MF	75	50	12	47	1	€ 10,8087
7550BYBY60	ANT. CILINDRICO 75/50	FF	75	50	12	-	1	€ 9,9236
7550DAY5060	ANT. CILINDRICO 75/50	PM	75	50	12	47	1	€ 10,2764
7555AY50AY5060	ANT. CILINDRICO 75/55	MM	75	55	12	47	1	€ 11,9847
7555AY50BY60	ANT. CILINDRICO 75/55	MF	75	55	12	47	1	€ 11,9847
7555BYBY60	ANT. CILINDRICO 75/55	FF	75	55	12	-	1	€ 9,2348
7560AY50AY5060	ANT. CILINDRICO 75/60	MM	75	60	12	47	1	€ 12,8688
7560AY50BY60	ANT. CILINDRICO 75/60	MF	75	60	12	47	1	€ 10,6302
7560BYBY60	ANT. CILINDRICO 75/60	FF	75	60	12	-	1	€ 12,6336
810040AZAZ60	ANT.CILINDRICO 100/40	MM	100	40	16	47	1	€ 17,8080
810040AZBZ60	ANT.CILINDRICO 100/40	MF	100	40	16	47	1	€ 17,7912
810040BZBZ60	ANT.CILINDRICO 100/40	FF	100	40	16	-	1	€ 15,6660
810040DAZ60	ANT.CILINDRICO 100/40	PM	100	40	16	47	1	€ 14,5467
810050AZAZ60	ANT.CILINDRICO 100/50	MM	100	50	16	47	1	€ 21,9471
810050AZBZ60	ANT.CILINDRICO 100/50	MF	100	50	16	47	1	€ 20,1495
810050BZBZ60	ANT.CILINDRICO 100/50	FF	100	50	16	-	1	€ 19,6004
810050DAZ60	ANT.CILINDRICO 100/50	PM	100	50	16	47	1	€ 17,5340
810055AZAZ60	ANT.CILINDRICO 100/55	MM	100	55	16	47	1	€ 17,4332
810055AZBZ60	ANT.CILINDRICO 100/55	MF	100	55	16	47	1	€ 16,8000
810055BZBZ60	ANT.CILINDRICO 100/55	FF	100	55	16	-	1	€ 17,7303
810060AZAZ60	ANT.CILINDRICO 100/60	MM	100	60	16	47	1	€ 21,2604
810060AZBZ60	ANT.CILINDRICO 100/60	MF	100	60	16	47	1	€ 20,6640
810060BZBZ60	ANT.CILINDRICO 100/60	FF	100	60	16	-	1	€ 19,5825
810080DAZ60	PARAB.TRONC. PTC 100/80	PM	100	80	16	47	1	€ 21,2604

ANTIVIBRANTI A CAMPANA TIPO SC1 / SC5
BELL SHAPED VIBRATION DAMPINGS TYPE SC1 / SC5

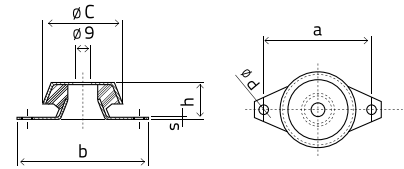

Codice Code	A	B	C	D	H	S	G	Q.tà Q.ty	Prezzo Unit Price
SC1/8	68	80	48	6,00	23	1,50	M8	20	€ 12,9413
SC1/10	68	80	48	6,00	23	1,50	M10	20	€ 12,9413
SC2/8	85	100	62	8,00	26	2,00	M8	10	€ 15,5978
SC2/10	85	100	62	8,00	26	2,00	M10	10	€ 15,5978
SC2/12	85	100	62	8,00	26	2,00	M12	10	€ 15,5978
SC3/10	110	129	92	10,00	44	3,00	M10	10	€ 23,6355
SC3/12	110	129	92	10,00	44	3,00	M12	10	€ 23,6355
SC3/14	110	129	92	10,00	44	3,00	M14	10	€ 24,2697
SC3/16	110	129	92	10,00	44	3,00	M16	10	€ 24,0524
SC4/16	160	190	120	16,00	40	4,00	M16	10	€ 32,8650
SC4/20	160	190	120	16,00	40	4,00	M20	10	€ 33,0351
SC5/16	200	230	160	16,50	60	5,00	M16	5	€ 83,1674
SC5/20	200	230	160	16,50	60	5,00	M20	5	€ 83,1674

ANTIVIBRANTI A CAMPANA TIPO SC6 / SC7
BELL SHAPED VIBRATION DAMPINGS TYPE SC6 / SC7

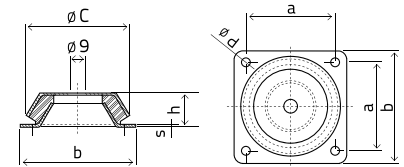

Codice Code	A	B	C	D	H	S	G	Q.tà Q.ty	Prezzo Unit Price
SC6/16	132X132	168X138	150	13	51,5	4,00	M16	5	€ 68,0106
SC6/20	132X132	168X168	150	13	51,5	4,00	M20	5	€ 68,5797
SC7/16	150X150	181X181	177	13	63	4,50	M16	5	€ 106,4574
SC7/20	150X150	181X181	177	13	63	4,50	M20	5	€ 106,4574

ANTIVIBRANTI A CAMPANA TIPO SCS
BELL SHAPED VIBRATION DAMPINGS TYPE SCS

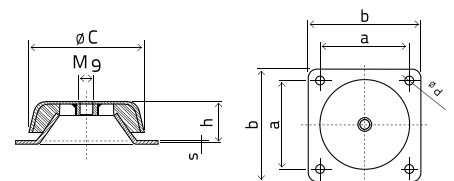

Codice Code	A	B	C	D	H	S	G	Q.tà Q.ty	Prezzo Unit Price
SCS108	88X88	08X108	92	9	44	3	M12	20	€ 29,7308
SCS150	132X132	168X168	150	3	51,5	4	M16	5	€ 77,9531



ACCESSORI PER OLEODINAMICA
HYDRAULICS ACCESSORIES

INGRASSATORI

GREASE NIPPLES

Gli ingrassatori sono particolari tipi di raccordi, dotati di una valvola unidirezionale e di una parte per l'accoppiamento a testine utilizzate per l'ingrassaggio. Situati all'interno del circuito di lubrificazione, permettono il suo riempimento attraverso una pompa ad ingrassaggio.

Gli ingrassatori Athena sono disponibili in diverse tipologie, dai più comuni a testa emisferica (diritti, a 45° o a 90°), che vanno abbinati a una testina a 3 o 4 griffe, a quelli con testa piana esagonale (a doppio esagono), da abbinare a una testina a gancio o a spinta.

Grease nipples are particular types of connection, provided with a one-way valve and a part to be coupled with heads used for greasing. Located into the lubrication circuit, they allow its filling through a grease pump.

Athena grease nipples are available in various models, divided in two categories: with semispherical head (straight, spout at 45° or at 90°) which are the most common and to be used with a 3 or 4 jaw head, or with flat head bolt (at double hexagon), used in combination with a head or hook thrust.



INGRASSATORI GREASE NIPPLES



Diritto
Straight



Beccuccio a 45°
Spout at 45°

Codice Code	mm	Filetto Thread	UNI 7663	Confezione Package	Prezzo Unit Price
Diritto / Straight					
ING014	7	M6 x 1	Lungo/Long	100	€ 0,880
ING006	7	M6 x 1	6 MA	100	€ 0,298
ING007	9	M8 X 1	8 MB passo fine/fine thread	100	€ 0,303
ING008	9	M8 X 1,25	8 MA	100	€ 0,347
ING009	11	M10 x 1	10 MB passo fine/fine thread	100	€ 0,358
ING010	11	M10 x 1,5	10 MA	100	€ 0,418
ING011	14	M12 x 1,5	12 MB	100	€ 0,990
ING012	14	1/4" Gas	UNI 338	100	€ 0,660
ING013	11	1/8" Gas	UNI 338	100	€ 0,413
Beccuccio a 45° / Spout 45°					
ING015	11	M6 x 1	6 MA	100	€ 0,737
ING016	11	M8 x 1	8 MB passo fine/fine thread	100	€ 0,770
ING017	11	M8 x 1,25	8 MA	100	€ 0,831
ING018	11	M10 x 1	10 MB passo fine/fine thread	100	€ 0,770
ING019	11	M10 X 1,5	10 MA	100	€ 0,831

INGRASSATORI GREASE NIPPLES



Beccuccio a 90°
Spout at 90°



Doppio Esagono
Double Hexagon

Codice Code	mm	Filetto Thread	UNI 7663	Confezione Package	Prezzo Unit Price
Beccuccio a 90° / Spout 90°					
ING020	11	M6 x 1	6 MA	100	€ 0,770
ING021	11	M8 x 1	8 MB passo fine/fine thread	100	€ 0,770
ING022	11	M8 x 1,25	8 MA	100	€ 0,831
ING023	11	M10 x 1	10 MB passo fine/fine thread	100	€ 0,880
ING024	11	M10 x 1,5	10 MA	100	€ 0,831
ING025	14	1/4" Gas	UNI 338	100	€ 0,880
Doppio esagono / Double hexagon					
ING001	15	M10 x 1	10 MB passo fine/fine thread	100	€ 0,880
ING002	15	M10 x 1,5	10 MA	100	€ 0,880
ING003	15	M12 x 1,5	12 MB passo fine/fine thread	100	prezzo in funzione del lotto/price TBD on items ordered
ING004	15	1/4" Gas	UNI 338	100	€ 0,880
ING005	15	1/8" Gas	UNI 338	100	€ 0,880

Standard: UNI 7663 non indurito/uncured
 Standard: UNI 7663 versione indurita/hardened
 Acciaio/Steel: UNI EN 10277-3
 Zincatura/Galvanizing: µ 7-IV



TAPPI E ACCESSORI PER OLEODINAMICA SCREW PLUGS AND HYDRAULIC ACCESSORIES

Tappi di chiusura per ogni applicazione, realizzati in ottone, alluminio, acciaio e acciaio inox, con resistenza alla pressione fino a 800 Bar. Tappi di sfiato per ogni tipologia di equipaggiamento a bagno d'olio quali riduttori, trasmissioni meccaniche in genere e centraline oleodinamiche. Spie di livello per resistere a diversi fluidi, pressioni e temperature. Infine, tappi magnetici da utilizzare come filtro per pulire l'olio da particelle ferrose.

Screw plugs for any application, made of brass, aluminium alloy, steel and stainless steel with high pressure resistance up to 800 Bar. Breather plugs for any oil bath equipment such as gearboxes or any power transmission equipment. Sight glass with different fluid, temperature and pressure resistance. Finally, magnetic plugs attract and hold abrasive, ferrous metal particles preventing their circulation through the lubrication or hydraulic system.



TAPPI DI CHIUSURA SCREW PLUGS



Codice Code	Modello Model	Filetto Thread	Conf.standard (pz) Standard package (pcs)	Prezzo Unit Price	Conf.mini (pz) Small package (pcs)	Prezzo Unit Price
010100011	11A Tappo a testa esagonale con filetto cilindrico in acciaio zincato Zinc plated steel screw plug with hexagon head	G 1/8	500	upon request	100	€ 0,44710
010100012		G 1/4	500	€ 0,31360	50	€ 0,54860
010100031		G 3/8	500	€ 0,37260	50	€ 0,65210
010100014		G 1/2	250	upon request	25	€ 1,46870
010100015		G 3/4	250	€ 1,07640	25	€ 1,88370
010100016		G 1	100	upon request	10	€ 3,73120
010100017	11B Tappo a testa esagonale con filetto cilindrico in acciaio zincato Zinc plated steel screw plug with hexagon head designed to be assembled with a washer	G 1/8	500	€ 0,29910	100	€ 0,52370
010100018		G 1/4	500	€ 0,31150	50	€ 0,54650
010100019		G 3/8	250	€ 0,45540	50	€ 0,79700
010100020		G 1/2	250	€ 0,97910	25	€ 1,71290
010100021		G 3/4	250	€ 1,10950	25	€ 1,94170
010100022		G 1	100	€ 2,35360	10	€ 4,11830
010100023	11C Tappo a testa esagonale in acciaio zincato con filetto conico Zinc plated steel screw plug with hexagon head and conical thread	R 1/8	500	€ 0,28980	100	€ 0,50720
010100024		R 1/4	500	€ 0,31570	50	€ 0,55270
010100025		R 3/8	500	€ 0,38610	50	€ 0,67590
010100026		R 1/2	250	€ 0,74730	25	€ 1,30720
010100007		R 3/4	100	€ 1,01430	10	€ 1,77610
010100008		R 1	100	€ 1,88370	10	€ 3,29650
010100042		M14x1,5c	500	€ 0,38710	50	€ 0,67690
010100028		M16x1,5c	250	€ 0,49680	25	€ 0,86940
010200005	11F Tappo flangiato in acciaio zincato con filetto cilindrico Flanged plug made of zinc plated steel	G 1/2	250	€ 0,36020	25	€ 0,62930
010200004		G 3/4	250	€ 0,52990	25	€ 0,92840
010200002		G 1	100	€ 0,56820	10	€ 0,99460
010200007		G 1 1/4	50	€ 1,20470	5	€ 2,10830
010200003		G 1 1/2	50	€ 1,81850	5	€ 3,18160
010200001		G 2	25	€ 3,31510	3	€ 5,80010
010100221	11G Tappo a testa esagonale con filetto cilindrico in lega d'alluminio Aluminium alloy screw plug with hexagon head	G 1/8	500	€ 0,32640	100	€ 0,57120
010100222		G 1/4	500	€ 0,39980	50	€ 0,69970
010100224		G 3/8	500	€ 0,67320	50	€ 1,17810
010100225		G 1/2	250	€ 0,96900	25	€ 1,69520
010100227		G 3/4	250	€ 1,61160	25	€ 2,82030
010100228		G 1	100	€ 1,96760	10	€ 3,44350
010100232		G 1 1/4	50	€ 6,42600	5	€ 11,24550
010100212		M10x1	500	€ 0,37330	100	€ 0,65380
010100213		M12x1,5	500	€ 0,51410	50	€ 0,89960
010100214		M14x1,5	500	€ 0,54160	50	€ 0,94860
010100215		M16x1,5	250	€ 0,79560	25	€ 1,39230
010100216		M18x1,5	250	€ 0,83640	25	€ 1,46370
010100219		M20x1,5	100	€ 0,97920	10	€ 1,71360
010100220		M22x1,5	100	€ 1,02000	10	€ 1,78500
010100234		M24x1,5	100	€ 1,42800	10	€ 2,49900
010100235		M30x1,5	50	€ 1,83600	5	€ 3,21300

TAPPI DI CHIUSURA
SCREW PLUGS



Codice Code	Modello Model	Filetto Thread	Conf.standard (pz) Standard package (pcs)	Prezzo Unit Price	Conf.mini (pz) Small package (pcs)	Prezzo Unit Price	
010100076	11H.C Tappo a testa esagonale con etichetta di carico in alluminio con filetto cilindrico Aluminium alloy screw plug with hexagon head with FILL ideogram	G 1/8	500	€ 0,55080	100	€ 0,96390	
010100099		G 1/4	500	€ 0,55590	50	€ 0,97410	
010100108		G 3/8	500	€ 0,71400	50	€ 1,24950	
010100111		G 1/2	250	€ 1,08220	25	€ 1,89310	
010100120		G 3/4	250	€ 1,64930	25	€ 2,88560	
010100125		G 1	100	€ 2,73160	10	€ 4,77970	
010100133		G 1 1/4	50	€ 6,07920	5	€ 10,63860	
010100079		M10x1	500	€ 0,58650	100	€ 1,02610	
010100082		M12x1,5	500	€ 0,61200	50	€ 1,07100	
010100085		M14x1,5	500	€ 0,66500	50	€ 1,16480	
010100089		M16x1,5	250	€ 0,67320	25	€ 1,17810	
010100129		M18x1,5	250	€ 0,68240	25	€ 1,19440	
010100092		M20x1,5	100	€ 0,96700	10	€ 1,69120	
010100095		M22x1,5	250	€ 1,22200	25	€ 2,13890	
010100077		11H.S Tappo a testa esagonale con etichetta di scarico in alluminio con filetto cilindrico Aluminium alloy screw plug with hexagon head with drain ideogram	G 1/8	500	€ 0,55080	100	€ 0,96390
010100100			G 1/4	500	€ 0,55590	50	€ 0,97410
010100109	G 3/8		500	€ 0,71400	50	€ 1,24950	
010100112	G 1/2		250	€ 1,08220	25	€ 1,89310	
010100121	G 3/4		250	€ 1,64930	25	€ 2,88560	
010100126	G 1		100	€ 2,73160	10	€ 4,77970	
010100134	G 1 1/4		50	€ 6,07920	5	€ 10,63860	
010100080	M10x1		500	€ 0,58650	100	€ 1,02610	
010100083	M12x1,5		500	€ 0,81700	50	€ 1,43000	
010100086	M14x1,5		500	€ 0,66500	50	€ 1,16480	
010100090	M16x1,5		250	€ 0,67320	25	€ 1,17810	
010100130	M18x1,5		250	€ 0,68240	25	€ 1,19440	
010100093	M20x1,5		250	€ 0,96700	25	€ 1,69120	
010100096	M22x1,5		250	€ 1,22200	25	€ 2,13890	
010100118	M24x2		100	€ 1,66570	10	€ 2,91410	
010100078	11H.L Tappo a testa esagonale con etichetta di livello in alluminio con filetto cilindrico Aluminium alloy screw plug with hexagon head with level ideogram		G 1/8	500	€ 0,55080	100	€ 0,96390
010100102		G 1/4	500	€ 0,55590	50	€ 0,97410	
010100110		G 3/8	500	€ 0,71400	50	€ 1,24950	
010100113		G 1/2	250	€ 1,08220	25	€ 1,89310	
010100122		G 3/4	250	€ 1,64930	25	€ 2,88560	
010100128		G 1	100	€ 2,73160	10	€ 4,77970	
010100135		G 1 1/4	50	€ 6,07920	5	€ 10,63860	
010100081		M10x1	500	€ 0,58650	100	€ 1,02610	
010100084		M12x1,5	500	€ 0,81700	50	€ 1,43000	
010100087		M14x1,5	500	€ 0,66500	50	€ 1,16480	
010100091		M16x1,5	250	€ 0,67320	25	€ 1,17810	
010100131		M18x1,5	250	€ 0,67320	25	€ 1,17810	
010100094		M20x1,5	250	€ 0,68240	25	€ 1,19440	
010100097		M22x1,5	250	€ 0,96700	25	€ 1,69120	

TAPPI DI CHIUSURA SCREW PLUGS



Codice Code	Modello Model	Filetto Thread	Conf.standard (pz) Standard package (pcs)	Prezzo Unit Price	Conf.mini (pz) Small package (pcs)	Prezzo Unit Price
010100177	11.C Tappo a testa esagonale con etichetta di carico in acciaio con filetto cilindrico Zinc plated steel screw plug with hexagon head with fill ideogram	G 1/8	500	€ 0,70380	100	€ 1,23270
010100136		G 1/4	500	€ 0,51750	50	€ 0,90560
010100139		G 3/8	500	€ 0,82390	50	€ 1,44180
010100142		G 1/2	250	€ 1,03500	25	€ 1,81130
010100147		G 3/4	250	€ 1,65600	25	€ 2,89800
010100150		G 1	100	€ 1,96650	10	€ 3,44140
010100202		G 1 1/4	50	€ 4,87490	5	€ 8,53050
010100153		M10x1	500	€ 0,71830	100	€ 1,25650
010100156		M12x1,5	500	€ 0,75560	50	€ 1,32270
010100159		M14x1,5	500	€ 0,80010	50	€ 1,39930
010100162		M16x1,5	250	€ 0,92740	25	€ 1,62290
010100165		M18x1,5	250	€ 1,03500	25	€ 1,81130
010100168		M20x1,5	250	€ 1,11780	25	€ 1,95620
010100171		M22x1,5	250	€ 1,20060	25	€ 2,10110
010100174		M24x2	100	€ 1,38690	10	€ 2,42710
010100178		11.S Tappo a testa esagonale con etichetta di scarico in acciaio con filetto cilindrico Zinc plated steel screw plug with hexagon head with drain ideogram	G 1/8	500	€ 0,70380	100
010100137	G 1/4		500	€ 0,51750	50	€ 0,90560
010100140	G 3/8		500	€ 0,82390	50	€ 1,44180
010100143	G 1/2		250	€ 1,03500	25	€ 1,81130
010100148	G 3/4		250	€ 1,65600	25	€ 2,89800
010100151	G 1		100	€ 1,96650	10	€ 3,44140
010100203	G 1 1/4		50	€ 4,87490	5	€ 8,53050
010100154	M10x1		500	€ 0,71830	100	€ 1,25650
010100157	M12x1,5		500	€ 0,75560	50	€ 1,32270
010100160	M14x1,5		500	€ 0,80010	50	€ 1,39930
010100163	M16x1,5		250	€ 0,92740	25	€ 1,62290
010100166	M18x1,5		250	€ 1,03500	25	€ 1,81130
010100169	M20x1,5		250	€ 1,11780	25	€ 1,95620
010100172	M22x1,5		250	€ 1,20060	25	€ 2,10110
010100175	M24x2		100	€ 1,38690	10	€ 2,42710

TAPPI DI CHIUSURA
SCREW PLUGS



Codice Code	Modello Model	Filetto Thread	Conf.standard (pz) Standard package (pcs)	Prezzo Unit Price	Conf.mini (pz) Small package (pcs)	Prezzo Unit Price	
010100179	11.L Tappo a testa esagonale con etichetta di livello in acciaio con filetto cilindrico	G 1/8	500	€ 0,70380	50	€ 1,23270	
010100138		G 1/4	500	€ 0,51750	50	€ 0,90560	
010100141		G 3/8	500	€ 0,82390	50	€ 1,44180	
010100145		G 1/2	250	€ 1,03500	25	€ 1,81130	
010100149		G 3/4	250	€ 1,65600	25	€ 2,89800	
010100152		G 1	100	€ 1,96650	10	€ 3,44140	
010100204		G 1 1/4	50	€ 4,87490	5	€ 8,53050	
010100155		Zinc plated steel screw plug with hexagon head with level ideogram	M10x1	500	€ 0,71830	100	€ 1,25650
010100158			M12x1,5	500	€ 0,75560	50	€ 1,32270
010100161			M14x1,5	500	€ 0,80010	50	€ 1,39930
010100164			M16x1,5	250	€ 0,92740	25	€ 1,62290
010100167			M18x1,5	250	€ 1,03500	25	€ 1,81130
010100170			M20x1,5	250	€ 1,11780	25	€ 1,95620
010100173			M22x1,5	250	€ 1,20060	25	€ 2,10110
010200030			11L Tappo DIN 910 in acciaio zincato	G 1/8	500	€ 0,59100	100
010200031	G 1/4	500		€ 0,76800	50	€ 1,30510	
010200032	G 3/8	500		€ 0,96050	50	€ 1,63220	
010200033	G 1/2	250		€ 1,19960	25	€ 2,03790	
010200034	G 3/4	250		€ 1,89820	25	€ 3,22710	
010200035	G 1	100		€ 3,21680	10	€ 5,46890	
010200040	Hexagon head flanged screw plug DIN 910 made of zinc plated steel	M10x1		500	€ 0,78660	50	€ 1,37660
010200041		M 12 X 1,5		500	€ 0,80730	50	€ 1,41280
010200042		M 14 X 1,5		500	€ 0,83010	50	€ 1,41070
010200043		M 16 X 1,5		250	€ 0,94910	25	€ 1,61360
010200044		M 18x1,5		250	€ 1,07950	25	€ 1,83510
010200045		M 20X1,5		250	€ 1,22850	25	€ 2,08760
010200046		M 22 X 1,5		250	€ 1,38790	25	€ 2,35880
010200047		M 24 X 1,5		100	€ 1,57940	10	€ 2,68480
010200048	M 26 X 1,5	100		€ 1,88780	10	€ 3,20850	

TAPPI DI CHIUSURA SCREW PLUGS



Codice Code	Modello Model	Filetto Thread	Conf.standard (pz) Standard package (pcs)	Prezzo Unit Price	Conf.mini (pz) Small package (pcs)	Prezzo Unit Price	
010100506	11M Tappo a testa esagonale in plastica con sede per rondella Plastic screw plug	G 1/4	500	€ 0,33710	50	€ 0,59010	
010100507		G 3/8	500	€ 0,36860	50	€ 0,64580	
010100508		G 1/2	250	€ 0,43370	25	€ 0,75920	
010100509		G 3/4	250	€ 0,59640	25	€ 1,04370	
010100510		G 1	100	€ 0,81590	10	€ 1,42800	
010100511		G 1 1/4	50	€ 1,21910	5	€ 2,13360	
010100512		G 1 1/2	50	€ 1,37240	5	€ 2,40140	
010100513		G 2	25	€ 2,28380	3	€ 3,99630	
010100516		M10x1,5	500	€ 0,32450	50	€ 0,56810	
010100517		M 12 X 1,5	500	€ 0,32450	50	€ 0,56810	
010100518		M 14 X 1,5	500	€ 0,32450	50	€ 0,56810	
010100519		M 16 X 1,5	250	€ 0,36860	25	€ 0,64580	
010100520		M 18x1,5	250	€ 0,38220	25	€ 0,66890	
010100521		M 20X1,5	100	€ 0,43370	10	€ 0,75920	
010100522		M 22 X 1,5	100	€ 0,44520	10	€ 0,77910	
010100523		M 40 X 1,5	25	€ 1,08780	3	€ 1,90260	
010400181		41B Testa cilindrica esagono incassato din 908 in acciaio zincato Hexagon socket din 908 zinc plated steel	G 1/8	500	€ 0,22670	100	€ 0,39640
010400182			G 1/4	500	€ 0,26190	50	€ 0,45850
010400184	G 3/8		500	€ 0,32290	50	€ 0,56510	
010400186	G 1/2		250	€ 0,53610	25	€ 0,93770	
010400187	G 3/4		100	€ 0,91080	10	€ 1,54840	
010400189	G 1		100	€ 1,60840	10	€ 2,81520	
010400190	G 1 1/4		50	€ 4,65750	5	€ 6,72750	
010400191	G 1 1/2		50	€ 7,76250	5	€ 13,45500	
010400168	M8x1		500	€ 0,19350	100	€ 0,33950	
010400169	M10x1		500	€ 0,19560	100	€ 0,34360	
010400170	M12x1,5		500	€ 0,26600	50	€ 0,46680	
010400171	M14x1,5		500	€ 0,30530	50	€ 0,53410	
010400172	M16x1,5		250	€ 0,41400	25	€ 0,72450	
010400173	M18x1,5		250	€ 0,46990	25	€ 0,82180	
010400174	M20x1,5		250	€ 0,51960	25	€ 0,90870	
010400175	M22x1,5		250	€ 0,56200	25	€ 0,98430	
010400176	M24x1,5		100	€ 0,80210	10	€ 1,40450	
010400177	M26x1,5		100	€ 1,03500	10	€ 1,81130	
010400178	M27x2		100	€ 1,24200	10	€ 2,17350	
010400179	M30x1,5		50	€ 1,32480	5	€ 2,31840	
010400180	M30x2		50	€ 1,32480	5	€ 2,31840	

TAPPI DI CHIUSURA
SCREW PLUGS



Codice Code	Modello Model	Filetto Thread	Conf.standard (pz) Standard package (pcs)	Prezzo Unit Price	Conf.mini (pz) Small package (pcs)	Prezzo Unit Price	
010400260	41C Tappo TCEI DIN 908 in acciaio inox Hexagon socket screw plugs DIN908 made of stainless steel	G 1/8	100	€ 1,91890	10	€ 3,35780	
010400261		G 1/4	100	€ 2,55440	10	€ 4,47020	
010400262		G 3/8	100	€ 3,09000	10	€ 5,40750	
010400263		G 1/2	50	€ 6,18820	5	€ 10,83050	
010400264		G 3/4	50	€ 7,31920	5	€ 12,80810	
010400265		G 1	25	€ 10,24130	3	€ 17,92200	
010400266		G 1 1/4	50	€ 21,63000	5	€ 31,41500	
010400267		G 1 1/2	50	€ 27,29500	5	€ 37,08000	
010400270		M10x1	100	€ 1,71800	10	€ 3,00760	
010400271		M12x1,5	100	€ 2,31030	10	€ 4,04280	
010400272		M14x1,5	100	€ 2,48950	10	€ 4,35690	
010400273		M16x1,5	100	€ 4,03760	10	€ 7,06580	
010400274		M18x1,5	100	€ 4,46400	10	€ 7,81260	
010400275		M20x1,5	100	€ 4,97900	10	€ 8,71380	
010400276		M22x1,5	100	€ 5,56200	10	€ 9,73350	
010400277		M24x1,5	25	€ 5,82360	3	€ 10,19190	
010400218		41D Tappo TCEI DIN 908 in lega d'alluminio Hexagon socket screw plugs DIN908 made of aluminium alloy	G 1/8	500	€ 0,21520	100	€ 0,37640
010400217			G 1/4	500	€ 0,27740	50	€ 0,48550
010400219	G 3/8		500	€ 0,40290	50	€ 0,70580	
010400220	G 1/2		250	€ 0,59260	25	€ 1,03730	
010400221	G 3/4		250	€ 1,19240	25	€ 2,08690	
010400222	G 1		100	€ 1,71160	10	€ 2,99470	
010400223	G 1 1/4		50	€ 9,99600	5	€ 16,83000	
010400224	G 1 1/2		50	€ 12,24000	5	€ 19,38000	
010400203	M8x1		500	€ 0,17340	100	€ 0,30290	
010400204	M10x1		500	€ 0,19890	100	€ 0,34880	
010400205	M12x1,5		500	€ 0,26830	50	€ 0,47020	
010400206	M14x1,5		500	€ 0,32950	50	€ 0,57530	
010400207	M16x1,5		250	€ 0,38960	25	€ 0,68240	
010400208	M18x1,5		250	€ 0,50180	25	€ 0,87920	
010400209	M20x1,5		250	€ 0,58960	25	€ 1,03120	
010400210	M22x1,5		250	€ 0,69260	25	€ 1,21180	
010400213	M26x1,5		100	upon request	10	upon request	
010400215	M27x2		100	€ 0,93530	10	€ 1,63710	
010400216	M30x1,5		50	€ 1,16890	5	€ 2,04610	
010400211	M30x2		50	€ 1,19540	5	€ 2,09100	

TAPPI DI CHIUSURA SCREW PLUGS



Codice Code	Modello Model	Filetto Thread	Conf.standard (pz) Standard package (pcs)	Prezzo Unit Price	Conf.mini (pz) Small package (pcs)	Prezzo Unit Price
010300056	42A Tappo conico esagono incassato din 906 Tapered screw plugs din 906, zinc plated steel	R 1/8	1.000	€ 0,10250	100	€ 0,18010
010300052		R 1/4	500	€ 0,14490	50	€ 0,25360
010300051		R 3/8	500	€ 0,19460	50	€ 0,34050
010300068		R 1/2	250	€ 0,37260	25	€ 0,65210
010300059		R 3/4	100	€ 0,55890	10	€ 0,97810
010300075		R 1	100	€ 0,78660	10	€ 1,37660
010300030		M8x1c	1.000	€ 0,12010	100	€ 0,21010
010300057		M10x1c	1.000	€ 0,12420	100	€ 0,21740
010300034		M12x1,5c	500	€ 0,18320	50	€ 0,32090
010300048		M14x1,5c	500	€ 0,23180	50	€ 0,40570
010300053		M16x1,5c	250	€ 0,31880	25	€ 0,55890
010300033		M18x1,5c	250	€ 0,34160	25	€ 0,59820
010300044		M20x1,5c	250	€ 0,41710	25	€ 0,72860
010300032		M22x1,5c	250	€ 0,45540	25	€ 0,79700
010300120		42A.S Tappo STEI DIN 906 in acciaio zincato e trattamento preapplicato sigillante (filetto conico) Hexagon socket pipe plug with conical thread DIN 906 made of zinc plated steel with Loctite Dry-seal 5061 coating	R 1/8	500	upon request	100
010300121	R 1/4		500	upon request	50	upon request
010300122	R 3/8		500	upon request	50	upon request
010300123	R 1/2		250	upon request	25	upon request
010300124	R 3/4		100	upon request	10	upon request
010300125	R 1		100	upon request	10	upon request
010300128	M8x1c		1.000	upon request	100	upon request
010300129	M10x1c		1.000	upon request	100	upon request
010300130	M12x1,5c		500	upon request	50	upon request
010300131	M14x1,5c		500	upon request	50	upon request
010300132	M16x1,5c		250	upon request	25	upon request
010300133	M18x1,5c		250	upon request	25	upon request
010300134	M20x1,5c		250	upon request	25	upon request
010300135	M22x1,5c		250	upon request	25	upon request
010300160	42B Scarico Tappo STEI DIN 906 in acciaio inox (filetto conico) Hexagon socket pipe plug with conical thread DIN 906 made of stainless steel		R 1/8	1.000	€ 1,72010	100
010300161		R 1/4	500	€ 2,61620	50	€ 4,57840
010300162		R 3/8	50	€ 3,60710	5	€ 6,31180
010300163		R 1/2	25	€ 4,14060	3	€ 7,24610
010300164		R 3/4	100	€ 7,25940	10	€ 12,70400
010300165		R 1	25	€ 13,59600	3	€ 23,79300
010300168		M8x1c	1.000	€ 1,44610	100	€ 2,53070
010300169		M10x1c	100	€ 1,63980	10	€ 2,86960
010300170		M12x1,5c	100	€ 2,06000	10	€ 3,60500
010300171		M14x1,5c	100	€ 3,25480	10	€ 5,69590
010300172		M16x1,5c	100	€ 3,44020	10	€ 6,02040
010300173		M18x1,5c	100	€ 3,73680	10	€ 6,53950
010300174		M20x1,5c	100	€ 4,49080	10	€ 7,85890
010300175		M22x1,5c	100	upon request	10	upon request

TAPPI DI CHIUSURA
SCREW PLUGS



Codice Code	Modello Model	Filetto Thread	Conf.standard (pz) Standard package (pcs)	Prezzo Unit Price	Conf.mini (pz) Small package (pcs)	Prezzo Unit Price	
020100211	43A Tappo TCEI ribassato con OR antisfilamento in acciaio zincato Short hexagon socket screw plugs with OR made of zinc plated steel	G 1/8	500	€ 0,41400	100	€ 0,72450	
020100212		G 1/4	500	€ 0,43470	50	€ 0,76070	
020100213		G 3/8	500	€ 0,49680	50	€ 0,86940	
020100214		G 1/2	250	€ 0,80320	25	€ 1,40550	
020100215		G 3/4	250	€ 1,17990	25	€ 2,06480	
020100216		G 1	100	€ 1,88370	10	€ 3,29650	
020100217		G 1 1/4	50	upon request	5	upon request	
020100218		G 1 1/2	50	upon request	5	upon request	
020100221		M10x1	500	€ 0,45540	100	€ 0,79700	
020100222		M12x1,5	500	€ 0,47610	50	€ 0,83320	
020100223		M14x1,5	500	€ 0,49680	50	€ 0,86940	
020100224		M16x1,5	250	€ 0,52580	25	€ 0,92010	
020100225		M18x1,5	250	€ 0,55890	25	€ 0,97810	
020100226		M20x1,5	250	€ 0,74520	25	€ 1,30410	
020100227		M22x1,5	250	€ 0,86940	25	€ 1,52150	
020100228		M24x1,5	100	€ 0,95220	10	€ 1,66640	
020300001		43B Tappo TCEI con guarnizione trapezoidale per alte pressioni in acciaio zincato Plug with hexagon socket with flat packing ring high pressure application	G 1/8	500	€ 0,46690	100	€ 0,81710
020300002			G 1/4	500	€ 0,52780	50	€ 0,92370
020300003	G 3/8		500	€ 0,56840	50	€ 0,99470	
020300004	G 1/2		250	€ 0,83230	25	€ 1,45650	
020300005	G 3/4		250	€ 1,23830	25	€ 2,16700	
020300006	G 1		100	€ 2,15180	10	€ 3,76570	
020300015	G 1 1/4		50	€ 8,22150	5	€ 12,18000	
020300016	G 1 1/2		50	€ 16,44300	5	€ 27,40500	
020300007	M10x1		500	€ 0,50750	100	€ 0,88810	
020300008	M12x1,5		500	€ 0,52780	50	€ 0,92370	
020300009	M14x1,5		500	€ 0,54810	50	€ 0,95920	
020300010	M16x1,5		250	€ 0,60900	25	€ 1,06580	
020300011	M18x1,5		250	€ 0,71050	25	€ 1,24340	
020300012	M20x1,5		250	€ 0,83230	25	€ 1,45650	
020300013	M22x1,5		250	€ 0,87290	25	€ 1,52760	

TAPPI DI CHIUSURA SCREW PLUGS



Codice Code	Modello Model	Filetto Thread	Conf.standard (pz) Standard package (pcs)	Prezzo Unit Price	Conf.mini (pz) Small package (pcs)	Prezzo Unit Price	
020100241	43C Tappo TCEI con OR antisfilamento per alte pressioni in acciaio zincato	G 1/8	500	€ 0,41400	100	€ 0,72450	
020100242		G 1/4	500	€ 0,43470	50	€ 0,76070	
020100243		G 3/8	500	€ 0,49680	50	€ 0,86940	
020100244		G 1/2	250	€ 0,81560	25	€ 1,42730	
020100245		G 3/4	250	€ 1,22750	25	€ 2,14870	
020100246		G 1	100	€ 1,92510	10	€ 3,36890	
020100247		G 1 1/4	50	upon request	5	upon request	
020100248		G 1 1/2	50	upon request	5	upon request	
020100250		Hexagon socket screw plugs with OR made of zinc plated steel	M10x1	500	€ 0,45540	100	€ 0,79700
020100251			M12x1,5	500	€ 0,47610	50	€ 0,83320
020100252			M14x1,5	500	€ 0,49680	50	€ 0,86940
020100253			M16x1,5	250	€ 0,52580	25	€ 0,92010
020100254			M18x1,5	250	€ 0,55890	25	€ 0,97810
020100255			M20x1,5	250	€ 0,74520	25	€ 1,30410
020100256			M22x1,5	250	€ 0,86940	25	€ 1,52150
020100257			M24x1,5	100	€ 0,95220	10	€ 1,66640
020100176		43F Tappo TCEI SAE J514 con OR in acciaio zincato	5/16 UNF	500	upon request	100	upon request
020100177	3/8 UNF		500	upon request	50	upon request	
020100155	7/16 UNF		500	€ 1,19030	50	€ 2,08350	
020100178	1/2 UNF		500	upon request	50	upon request	
020100156	9/16 UNF		250	€ 1,39100	25	€ 2,43430	
020100179	3/4 UNF		250	€ 1,53180	25	€ 2,68070	
020100157	7/8 UNF		250	€ 1,59390	25	€ 2,78930	
020100180	Hexagon socket screw plugs with OR made of zinc plated steel		1 1/16 UNF	100	upon request	10	upon request
020100181			1 3/16-12UNF	100	upon request	10	upon request
020100182			1 5/16-12UNF	100	upon request	10	upon request
020100183			1 5/8-12 UNF	100	upon request	10	upon request
020100184			1 7/8-12 UNF	100	upon request	10	upon request

TAPPI DI SFIATO
BREATHER PLUGS



Codice Code	Modello Model	Filetto Thread	Conf.standard (pz) Standard package (pcs)	Prezzo Unit Price	Conf.mini (pz) Small package (pcs)	Prezzo Unit Price
130200021	30A Sfiato in ottone con labirinto Breather plug labyrinth version made of brass	G 1/8	250	€ 1,13950	25	€ 1,99410
130200010		G 1/4	250	€ 1,24700	25	€ 2,18230
130200027		G 3/8	250	€ 1,52650	25	€ 2,67140
130200032		R 3/8	250	€ 1,46200	25	€ 2,55850
130200017		G 1/2	100	€ 2,10700	10	€ 3,68730
130200034		R 1/2	100	€ 1,91350	10	€ 3,34860
130200018		G 3/4	100	€ 4,08500	10	€ 7,14880
130200049		R 3/4	100	€ 4,08500	10	€ 7,14880
130200014		G 1	50	€ 7,69700	5	€ 13,46980
130200044		G 1 1/4	25	€ 19,52200	3	€ 34,16350
130200036		M10x1c	250	€ 1,07500	25	€ 1,88130
130200019		M10x1	250	€ 1,07500	25	€ 1,88130
130200037		M12x1,5	250	€ 1,18250	25	€ 2,06940
130200031		M14x1,5	250	€ 1,33300	25	€ 2,33280
130200012		M16x1,5	250	€ 1,48350	25	€ 2,59610
130200029		M18x1,5	100	€ 1,67700	10	€ 2,93480
130200038		M20x1,5	250	€ 1,84900	25	€ 3,23580
130200024		M22x1,5	100	€ 2,64450	10	€ 4,62790
130200022		M24x2	100	€ 3,87000	10	€ 6,77250
130200040		M30x2	50	€ 5,59000	5	€ 9,78250
130200058	30A.A Sfiato in lega d'alluminio con labirinto Breather plug labyrinth version made of aluminium alloy	G 1/4	250	€ 1,14240	25	€ 1,99920
130200059		G 3/8	250	€ 1,38720	25	€ 2,42760
130200008		G 1/2	100	€ 2,20320	10	€ 3,85560
130200060		G 1/2	100	€ 1,95430	10	€ 3,42010
130200061		G 3/4	100	€ 3,65160	10	€ 6,39030
130200062		G 1	50	€ 6,93600	5	€ 12,13800
130200004		M14x1,5	250	€ 1,12200	25	€ 1,96350
130200050		M18x1,5	100	€ 1,59120	10	€ 2,78460
130200005		M20x1,5	250	€ 1,69320	25	€ 2,96310
130200054		M22x1,5	100	€ 2,20320	10	€ 3,85560
130200052	M30x2	50	€ 3,85560	5	€ 6,74730	
130200100	30A.I Sfiato in acciaio inox con labirinto Breather plug labyrinth version made of stainless steel	G 1/8	250	€ 11,84500	25	€ 20,72880
130200101		G 1/4	250	€ 13,90500	25	€ 24,33380
130200102		G 3/8	250	€ 15,45000	25	€ 27,03750
130200103		G 1/2	100	€ 18,54000	10	€ 32,44500
130200126		G 3/4	100	€ 81,20000	10	€ 142,10000
130200085		G 1	50	upon request	5	upon request
130200086	G 2	25	upon request	3	upon request	

TAPPI DI SFIATO BREATHER PLUGS

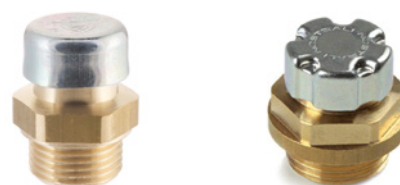

Codice Code	Modello Model	Filetto Thread	Conf.standard (pz) Standard package (pcs)	Prezzo Unit Price	Conf.mini (pz) Small package (pcs)	Prezzo Unit Price	
130100018	30B Sfiato semplice in ottone Breather plug free flow version made of brass	G 1/8	250	€ 1,06000	25	€ 1,85440	
130100019		G 1/4	250	€ 1,07930	25	€ 1,88990	
130100023		G 3/8	250	€ 1,29970	25	€ 2,27470	
130100025		R 3/8	250	€ 1,22010	25	€ 2,13500	
130100027		G 1/2	100	€ 1,95970	10	€ 3,42930	
130100029		R 1/2	100	€ 1,77910	10	€ 3,11430	
130100032		G 3/4	100	€ 3,79910	10	€ 6,64890	
130100034		G 1	50	€ 7,15840	5	€ 12,52700	
130100043		G 1 1/4	25	€ 18,15570	3	€ 31,77160	
130100005		M10x1	250	€ 0,99980	25	€ 1,75010	
130100006		M 10x1c	250	€ 0,99980	25	€ 1,75010	
130100007		M 12 x 1,5	250	€ 1,09970	25	€ 1,92430	
130100008		M 14 x 1,5	250	€ 1,12020	25	€ 1,95970	
130100010		M 16x1,5	250	€ 1,37920	25	€ 2,41450	
130100011		M 18x1,5	100	€ 1,42010	10	€ 2,48430	
130100012		M 20x1,5	250	€ 2,27900	25	€ 3,98830	
130100014		M 22x1,5	100	€ 2,45960	10	€ 4,30430	
130100017		M24x2	100	€ 3,59910	10	€ 6,29840	
130100046		30B.A Sfiato semplice in alluminio Breather plug free flow version made of aluminium alloy	G 1/4	250	€ 0,97920	25	€ 1,71360
130100047			G 3/8	250	€ 1,14240	25	€ 1,99920
130100048	G 1/2		100	€ 1,69320	10	€ 2,96310	
130100049	G 3/4		100	€ 3,42720	10	€ 5,99760	
130100050	G 1		50	upon request	5	upon request	
130100051	G 1 1/4		25	upon request	3	upon request	
130300095	30B.P Sfiato semplice in plastica con filtro Breather plug made of plastic with filter	G 3/8	250	€ 1,42910	25	€ 2,50010	
130300096		G 1/2	100	€ 1,61910	10	€ 2,83290	
130300097		G 3/4	100	€ 1,80920	10	€ 3,16580	
130300098		G 1	50	€ 2,23650	5	€ 3,91440	
130300099		G 1 1/4	25	€ 2,83500	3	€ 4,96130	
130300100		G 1 1/2	25	€ 2,97990	3	€ 5,21430	
130300105		M16x1,5	250	€ 1,42910	25	€ 2,50010	
130300106		M18x1,5	250	€ 1,52570	25	€ 2,66910	
130300107		M20x1,5	250	€ 1,61910	25	€ 2,83290	
130300108		M22x1,5	100	€ 1,66950	10	€ 2,92220	

TAPPI DI SFIATO
BREATHER PLUGS



Codice Code	Modello Model	Filetto Thread	Conf.standard (pz) Standard package (pcs)	Prezzo Unit Price	Conf.mini (pz) Small package (pcs)	Prezzo Unit Price
130300020	31A Sfiato in ottone con labirinto e filtro sinterizzato Breather plug bronze sinterized filter version made of brass	G 1/8	250	€ 1,36740	25	€ 2,39300
130300021		G 1/4	250	€ 1,50500	25	€ 2,63380
130300009		G 3/8	250	€ 1,67700	25	€ 2,93480
130300022		R 3/8	250	€ 1,56950	25	€ 2,74660
130300013		G 1/2	100	€ 2,42310	10	€ 4,24090
130300023		R 1/2	100	€ 2,20050	10	€ 3,85070
130300002		G 3/4	100	€ 4,69780	10	€ 8,22160
130300016		G 1	50	€ 8,57850	5	€ 15,01240
130300037		G 1 1/4	25	€ 21,47420	3	€ 37,57990
130300024		M10x1	250	€ 1,29000	25	€ 2,25750
130300025		M10x1c	250	€ 1,29000	25	€ 2,25750
130300019		M12x1,5	250	€ 1,41900	25	€ 2,48330
130300027		M14x1,5	250	€ 1,44480	25	€ 2,52840
130300005		M16x1,5	250	€ 1,70600	25	€ 2,98530
130300003		M18x1,5	100	€ 1,75550	10	€ 3,07240
130300029		M20x1,5	250	€ 2,12640	25	€ 3,72170
130300017		M22x1,5	100	€ 3,04120	10	€ 5,32230
130300030		M24x2	100	€ 4,42900	10	€ 7,75080
130300031		M30x2	50	€ 5,99850	5	€ 10,49740
130300032		31A.A Sfiato in lega d'alluminio con labirinto e filtro sinterizzato Breather plug bronze sinterized filter version made of aluminium alloy	G 1/4	250	€ 1,30560	25
130300042	G 3/8		250	€ 1,55040	25	€ 2,71320
130300012	G 1/2		100	€ 2,40720	10	€ 4,21260
130300044	G 3/4		100	€ 3,97800	10	€ 6,96150
130300015	G 1		50	€ 7,26240	5	€ 12,70920
130300046	G 1 1/4		25	upon request	3	upon request
130300004	M14x1,5		250	€ 1,26480	25	€ 2,21340
130300006	M20x1,5		250	€ 1,89720	25	€ 3,32010
130300070	31A.I Tappo sfiato con labirinto e filtro sinterizzato in acciaio inox Breather plug bronze sinterized filter version made of stainless steel	G 1/8	250	€ 12,87500	25	€ 22,66000
130300071		G 1/4	250	€ 14,93500	25	€ 24,07630
130300072		G 3/8	250	€ 16,99500	25	€ 29,74130
130300073		G 1/2	100	€ 19,57000	10	€ 34,24750
130300074		G 3/4	100	€ 91,67000	10	€ 175,10000
130300075	G 1	50	€ 133,90000	5	upon request	

TAPPI DI SFIATO BREATHER PLUGS

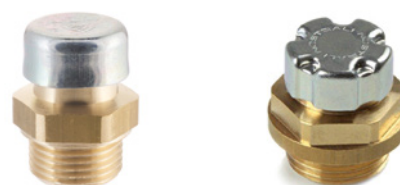

Codice Code	Modello Model	Filetto Thread	Conf.standard (pz) Standard package (pcs)	Prezzo Unit Price	Conf.mini (pz) Small package (pcs)	Prezzo Unit Price
130400606	33A Sfiato in ottone con sistema a valvola Breather plug inner valve version made of brass	G 1/8	250	€ 1,13950	25	€ 1,99410
130400004		G 1/4	250	€ 1,16100	25	€ 2,03180
130400007		G 3/8	250	€ 1,39750	25	€ 2,44560
130400033		R 3/8	250	€ 1,31150	25	€ 2,29510
130400035		G 1/2	100	€ 2,10700	10	€ 3,68730
130400031		R 1/2	100	€ 1,91350	10	€ 3,34860
130400038		G 3/4	100	€ 4,08500	10	€ 7,14880
130400054		R 3/4	100	€ 4,08500	10	€ 7,14880
130400060		G 1	50	€ 7,69700	5	€ 13,46980
130400067		G 1 1/4	25	€ 19,52200	3	€ 34,16350
130400077		G 1 1/2	25	€ 36,55000	3	€ 63,96250
130400595		M10x1	250	€ 1,07500	25	€ 1,88130
130400053		M12x1,5	250	€ 1,18250	25	€ 2,06940
130400019		M14x1,5	250	€ 1,20400	25	€ 2,10700
130400017		M16x1,5	250	€ 1,48350	25	€ 2,59610
130400022		M18x1,5	100	€ 1,52650	10	€ 2,67140
130400025		M20x1,5	100	€ 1,84900	10	€ 3,23580
130400046		M22x1,5	100	€ 2,64450	10	€ 4,62790
130400098		M24x1,5	100	€ 3,87000	10	€ 6,77250
130400043		M24x2	100	€ 3,91300	10	€ 6,84780
130400068		M30x2	50	€ 5,59000	5	€ 9,78250
130400062		M33x2	50	€ 8,46670	5	€ 14,81670
130400112		33A.A Sfiato in lega d'alluminio con valvola Breather plug inner valve version made of aluminium alloy	G 1/4	250	€ 1,04040	25
130400113	G 3/8		250	€ 1,18320	25	€ 2,07060
130400114	G 1/2		100	€ 1,79520	10	€ 3,14160
130400333	G 3/4		100	upon request	10	upon request
130400104	G 1		50	upon request	5	upon request
130400110	M14x1,5		250	€ 1,12200	25	€ 1,96350
130400105	M18x1,5		100	€ 1,34640	10	€ 2,35620
130400440	33A.I Sfiato in acciaio inox con valvola Breather plug inner valve version made of stainless steel	G 1/8	250	€ 12,87500	25	€ 22,66000
130400441		G 1/4	250	€ 14,93500	25	€ 26,13630
130400442		G 3/8	250	€ 16,99500	25	€ 29,74130
130400443		G 1/2	100	€ 19,57000	10	€ 34,24750
130400389		G 3/4	100	€ 91,67000	10	€ 175,10000
130400390		G 1	50	€ 133,90000	5	upon request
130400393		G 2	25	€ 216,30000	3	upon request
130400078		33A.IP65 Sfiato in ottone con sistema a valvola con grado di protezione IP65 Breather plug inner valve version made of brass. IP65 approved	G 1/4	250	€ 1,74150	25
130400128	G 3/8		250	€ 1,98900	25	€ 3,48130
130400465	G 1/2		100	€ 3,16050	10	€ 5,53090
130400464	G 3/4		100	€ 2,87030	10	€ 5,02350
130400463	G 1		50	€ 6,12750	5	€ 10,72310

TAPPI DI SFIATO
BREATHER PLUGS



Codice Code	Modello Model	Filetto Thread	Conf.standard (pz) Standard package (pcs)	Prezzo Unit Price	Conf.mini (pz) Small package (pcs)	Prezzo Unit Price
130300116	35F.O Sfiatech in ottone con sistema a filtro	G 1/4	250	€ 1,24700	25	€ 2,18230
130300117	Sfiatech made of brass with filter	G 3/8	250	€ 1,49430	25	€ 2,62300
130300118		G 1/2	100	€ 2,21450	10	€ 3,87000
130300122	35F.A Sfiatech in alluminio con sistema a filtro	G 1/4	250	€ 1,13510	25	€ 1,98790
130300123	Sfiatech made of aluminium alloy with filter	G 3/8	250	€ 1,25250	25	€ 2,19390
130300124		G 1/2	100	€ 1,90960	10	€ 3,39900
130300135	35F.OC Sfiatech conico in ottone con sistema a filtro	R 1/4	250	€ 1,09650	25	€ 1,91350
130300136	Sfiatech made of brass with filter conical thread	R 3/8	250	€ 1,18250	25	€ 2,08550
130300137		R 1/2	100	€ 1,69850	10	€ 2,98850
130100165	35L.O Sfiatech in ottone libero	G 1/4	250	€ 1,18250	25	€ 2,06940
130100166	Sfiatech free flow version made of brass	G 3/8	250	€ 1,39750	25	€ 2,44560
130100167		G 1/2	100	€ 2,10700	10	€ 3,68730
130100170	35L.A Sfiatech in alluminio libero	G 1/4	250	€ 1,06590	25	€ 1,86660
130100171	Sfiatech free flow version made of aluminium alloy	G 3/8	250	€ 1,25970	25	€ 2,01760
130100172		G 1/2	100	€ 1,89920	25	€ 3,32420
130100175	35L.OC Sfiatech conico in ottone libero	R 1/4	250	€ 1,07500	25	€ 1,88130
130100176	Sfiatech free flow version made of brass conical thread	R 3/8	250	€ 1,11800	25	€ 1,95650
130100177		R 1/2	100	€ 1,56950	10	€ 2,75200
130400506	35V.O Sfiatech in ottone con sistema a valvola	G 1/4	250	€ 1,29000	25	€ 2,25750
130400507	Sfiatech with inner valve made of brass	G 3/8	250	€ 1,53730	25	€ 2,68750
130400508		G 1/2	100	€ 2,25750	10	€ 3,95600
130400496	35V.A Sfiatech in alluminio con sistema a valvola	G 1/4	250	€ 1,16280	25	€ 2,04000
130400497	Sfiatech with inner valve made of aluminium alloy	G 3/8	250	€ 1,27600	25	€ 2,24400
130400498		G 1/2	100	€ 1,92780	10	€ 3,36600
130400526	35V.OC Sfiatech conico in ottone con sistema a valvola	R 1/4	250	€ 1,18250	25	€ 2,07480
130400527	Sfiatech with inner valve made of brass conical thread	R 3/8	250	€ 1,26850	25	€ 2,21450
130400528		R 1/2	100	€ 1,80600	10	€ 3,16050

TAPPI MAGNETICI MAGNETIC SCREW PLUGS



Codice Code	Modello Model	Filetto Thread	Conf.standard (pz) Standard package (pcs)	Prezzo Unit Price	Conf.mini (pz) Small package (pcs)	Prezzo Unit Price	
110100009	36A Tappo magnetico a testa esagonale in alluminio con magnete in neodimio e etichetta	G 1/4	250	€ 1,49610	25	€ 2,61870	
110100012		G 3/8	250	€ 2,30410	25	€ 4,03160	
110100013		G 1/2	100	€ 2,56490	10	€ 4,48930	
110100017		G 3/4	100	€ 3,42060	10	€ 5,98550	
110100019		G 1	50	€ 4,15640	5	€ 7,27350	
110100045		G 1 1/4	25	€ 9,02540	3	€ 15,79440	
110100043		G 1 1/2	25	€ 17,10070	3	€ 29,92630	
110100002		Magnetic screw plug with neodmium made of aluminium alloy with filter ideogram	M14x1,5	250	€ 1,84730	25	€ 3,23280
110100016			M16x1,5	250	€ 2,32740	25	€ 4,07320
110100032			M18x1,5	100	€ 2,35180	10	€ 4,11480
110100006			M20x1,5	250	€ 2,42280	25	€ 4,23970
110100007			M22x1,5	100	€ 2,56490	10	€ 4,48930
110100049			M30x2	50	€ 3,56270	5	€ 6,23510
110400012	36B Tappo magnetico TCEI tratto da DIN908 in lega d'alluminio con magnete in neodimio		G 1/8	250	€ 1,15000	25	€ 2,01170
110400003		G 1/4	250	€ 1,27990	25	€ 2,24010	
110400005		G 3/8	250	€ 1,35810	25	€ 2,37710	
110400008		G 1/2	100	€ 1,88080	10	€ 3,29160	
110400010		G 3/4	100	€ 2,87350	10	€ 5,02930	
110400011		G 1	50	€ 3,55350	5	€ 6,21790	
110400016		M10x1	250	€ 1,30630	25	€ 2,28580	
110400013		M12x1,5	250	€ 1,35810	25	€ 2,37710	
110400019		Magnetic screw plug with hexagon socket made of aluminium alloy with neodmium magnet	M14x1,5	250	€ 1,48900	25	€ 2,60650
110400014			M16x1,5	250	€ 1,61990	25	€ 2,83490
110400001			M18x1,5	100	€ 1,88080	10	€ 3,29160
110400002			M20x1,5	250	€ 2,08990	25	€ 3,65810
110400017			M22x1,5	100	€ 2,19440	10	€ 3,84080
110400021	M24x2		100	€ 2,32540	10	€ 4,06910	
110400023	M30x2		50	€ 4,17980	5	€ 7,31510	
110400185	36C Tappo magnetico TCEI tratto da DIN908 in acciaio con magnete in neodimio	G 1/8	250	€ 1,26880	25	€ 2,22080	
110400186		G 1/4	250	€ 1,33980	25	€ 2,34470	
110400187		G 3/8	250	€ 1,52250	25	€ 2,66540	
110400188		G 1/2	100	€ 1,81790	10	€ 3,18100	
110400189		G 3/4	100	€ 2,56900	10	€ 4,49650	
110400190		G 1	50	€ 3,46120	5	€ 6,05750	
110400191		G 1 1/4	25	€ 14,51450	3	€ 9,23650	
110400192		G 1 1/2	25	€ 12,18000	3	€ 21,31500	

TAPPI MAGNETICI
MAGNETIC SCREW PLUGS



Codice Code	Modello Model	Filetto Thread	Conf.standard (pz) Standard package (pcs)	Prezzo Unit Price	Conf.mini (pz) Small package (pcs)	Prezzo Unit Price
110400210	36C.I Tappo magnetico TCEI tratto da DIN908 in acciaio inox con magnete in neodimio Magnetic screw plug with hexagon socket made of stainless steel with neodymium magnet	G 1/8	250	€ 3,56690	25	€ 5,51050
110400211		G 1/4	250	€ 4,20240	25	€ 6,13880
110400212		G 3/8	250	€ 4,73800	25	€ 6,50960
110400213		G 1/2	100	€ 7,83620	10	€ 9,02280
110400214		G 3/4	100	€ 8,96720	10	€ 13,78140
110400215		G 1	50	€ 11,88930	5	€ 17,03620
110400216		G 1 1/4	25	€ 23,27800	3	upon request
110400217		G 1 1/2	25	€ 28,94300	3	upon request
110400207	36B.Z Tappo magnetico TCEI tratto da DIN908 in acciaio zincato con magnete in neodimio Magnetic screw plug with hexagon socket made of zinc plated steel with neodymium magnet	G 1/4	250	€ 1,21800	25	€ 2,13150
110400034		G 3/8	250	€ 1,38450	25	€ 2,42280
110400020		G 1/2	100	€ 1,65240	10	€ 2,89170
110400022		G 3/4	100	€ 2,33550	10	€ 4,08740
110400165		G 1	50	€ 3,14650	5	€ 5,50640
110400038		M14x1,5	250	€ 1,33270	25	€ 2,33150
110400024		M18x1,5	100	€ 1,82900	10	€ 3,20030
110400031		M22x1,5	100	€ 2,35180	10	€ 4,11480
110400030		M30x2	50	€ 2,89480	5	€ 5,06590
110200073		36L.A Tappo magnetico tratto da DIN 910 in acciaio zincato con magnete in alnico Magnetic drain for high temperature with alnico plug base on DIN 910 made of zinc plated steel	G 1/4	500	€ 1,31850	50
110200074	G 3/8		500	€ 1,64730	50	€ 2,88260
110200075	G 1/2		250	€ 2,05740	25	€ 3,60120
110200076	G 3/4		250	€ 3,25820	25	€ 5,70430
110200077	G 1		100	€ 5,52060	10	€ 9,76430
110200085	M10X1		250	€ 1,33980	25	€ 2,27770
110200090	M12X1,5		250	€ 1,40070	25	upon request
110200078	M14X1,5		250	€ 1,42400	25	€ 2,41980
110200079	M16X1,5		250	€ 1,62910	25	€ 2,76890
110200080	M18X1,5		100	€ 1,85240	10	€ 3,14950
110200081	M20X1,5		100	€ 2,10710	10	€ 3,58300
110200082	M22X1,5		100	€ 2,38120	10	€ 4,04780
110200083	M24X1,5		100	€ 2,71110	10	€ 4,60810
110200084	M26X1,5		50	€ 3,23890	5	€ 5,50640

TAPPI MAGNETICI MAGNETIC SCREW PLUGS



Codice Code	Modello Model	Filetto Thread	Conf.standard (pz) Standard package (pcs)	Prezzo Unit Price	Conf.mini (pz) Small package (pcs)	Prezzo Unit Price	
110600001	36N Tappo magnetico TCEI con OR con magnete al neodimio incassato in acciaio zincato	G 1/8	250	€ 0,77750	25	€ 1,36010	
110600002		G 1/4	250	€ 1,03630	25	€ 1,81280	
110600003		G 3/8	250	€ 1,13880	25	€ 1,99350	
110600006		G 1/2	100	€ 2,00060	10	€ 3,50180	
110600007		G 3/4	100	€ 2,37610	10	€ 4,15740	
110600008		G 1	50	€ 3,66210	5	€ 6,40870	
110600009		G 1 1/4	25	€ 8,93200	3	€ 15,63100	
110600010		Magnetic drain plug with hexagon socket and O ring made of zinc plated steel with neodymium magnet	G 1 1/2	25	€ 25,45620	3	€ 44,54840
110600093			M14X1,5	250	€ 1,26880	25	€ 2,22080
110600094	M16X1,5		250	€ 1,50220	25	€ 2,62890	
110600005	M18X1,5		100	€ 1,90820	10	€ 3,33940	
110600095	M20X1,5		100	€ 2,39540	10	€ 4,19200	
110600096	M22X1,5		100	€ 2,49690	10	€ 4,36960	
110600030	36N.F Tappo magnetico TCEI con OR con magnete in ferrite incassato in acciaio zincato	G 1/8	250	€ 0,68410	25	€ 1,19670	
110600031		G 1/4	250	€ 0,91150	25	€ 1,59560	
110600032		G 3/8	250	€ 1,00180	25	€ 1,75390	
110600033		G 1/2	100	€ 1,76100	10	€ 3,08150	
110600034		G 3/4	100	€ 2,09090	10	€ 3,65910	
110600035		G 1	50	€ 3,22260	5	€ 5,63930	
110600036		G 1 1/4	25	€ 7,86020	3	€ 13,75530	
110600037		Magnetic drain plug with hexagon socket and O ring made of zinc plated steel with ferrite magnet	G 1 1/2	25	€ 22,40110	3	€ 39,20230
110600052			M 14 X 1,5	250	€ 1,14190	25	€ 1,99850
110600053			M 16 X 1,5	250	€ 1,35200	25	€ 2,36600
110600054			M 18x1,5	100	€ 1,71740	10	€ 3,00540
110600055			M 20X1,5	100	€ 2,15590	10	€ 3,77280
110600056	M 22 X 1,5		100	€ 2,24720	10	€ 3,93310	
110600100	36N.H Tappo magnetico TCEI con OR FKM con magnete in neodimio 120°C incassato in acciaio zincato	G 1/8	250	€ 1,04950	25	€ 1,36010	
110600101		G 1/4	250	€ 1,39870	25	€ 1,81280	
110600102		G 3/8	250	€ 1,53770	25	€ 1,99350	
110600103		G 1/2	100	€ 2,70090	10	€ 3,50180	
110600104		G 3/4	100	€ 3,20740	10	€ 4,15740	
110600105		G 1	50	€ 4,94410	5	€ 6,40870	
110600106		G 1 1/4	25	€ 12,05820	3	€ 15,63100	
110600107		Magnetic drain plug with neodymium magnet and FKM OR for high temperature applications	G 1 1/2	25	€ 34,36590	3	€ 50,63840
110600112			M 14 X 1,5	250	€ 1,71330	25	€ 2,99730
110600113			M 16 X 1,5	250	€ 2,02800	25	€ 3,54950
110600114			M 18x1,5	100	€ 2,57610	10	€ 4,50860
110600115			M 20X1,5	100	€ 3,23380	10	€ 5,65960
110600116			M 22 X 1,5	100	€ 3,37080	10	€ 5,89920

SPIE DI LIVELLO
LEVEL SIGHT WINDOWS



Codice Code	Modello Model	Filetto Thread	Conf.standard (pz) Standard package (pcs)	Prezzo Unit Price	Conf.mini (pz) Small package (pcs)	Prezzo Unit Price
140100015	38A Spia di livello olio in alluminio e plastica Sight Glass made of aluminium alloy with plastic window	G 1/4	250	€ 0,89320	25	€ 1,56310
140100020		G 3/8	250	€ 1,09620	25	€ 1,91840
140100024		G 1/2	100	€ 1,46160	10	€ 2,55780
140100038		G 3/4	100	€ 2,07060	10	€ 3,62360
140100044		G 1	50	€ 2,86230	5	€ 5,00900
140100057		G 1 1/4	25	€ 4,87200	3	€ 8,52600
140100059		G 1 1/2	25	€ 10,15000	3	€ 17,25500
140100006		M14x1,5	250	€ 0,97440	25	€ 1,70520
140100009		M16x1,5	250	€ 1,11650	25	€ 1,95390
140100033		M18x1,5	100	€ 1,13680	10	€ 1,98940
140100011		M20x1,5	250	€ 1,48190	25	€ 2,59330
140100013		M22x1,5	100	€ 1,50220	10	€ 2,62890
140100047		M24x1,5	100	€ 1,66460	10	€ 2,91310
140100051		M24x2	100	€ 1,80670	10	€ 3,16170
140100068		M30x2	50	€ 2,76080	5	€ 4,83140
140100027	38A.O Scarico Ideogr. Spia livello olio in ottone e plastica Sight Glass made of brass alloy with plastic window	G 1/4	250	€ 1,17040	25	€ 2,04820
140100018		G 3/8	250	€ 1,33760	25	€ 2,34080
140100002		G 1/2	100	€ 1,75560	10	€ 3,07230
140100042		G 3/4	100	€ 2,59160	10	€ 4,53530
140100143		G 1 1/4	25	€ 5,64300	3	€ 9,87530
140100064		M16x1,5	250	€ 2,41920	25	€ 4,23330
140100030		M18x1,5	100	€ 1,52570	10	€ 2,67000
140100036		M22x1,5	100	€ 1,91100	10	€ 3,34430
140100061		M24x2	100	€ 2,75880	10	€ 4,82790
140200002	38B Spia livello alte temperature ottone e vetro Sight Glass high performance made of brass with real glass window	G 1/2	100	€ 4,76520	10	€ 8,33910
140200004		G 3/4	100	€ 6,16550	10	€ 10,78960
140200005		G 1	50	€ 9,61400	5	€ 16,82450
140200006		G 1 1/4	25	€ 16,72000	3	€ 29,26000
140200010		G 1 1/2	25	€ 21,94500	3	€ 38,40380
140200011		G 2	10	€ 41,80000	3	€ 73,15000
140200017	38B.I Spia livello alte temperature inox+vetro Sight Glass high performance made of stainless steel with real glass window	G 1/2	100	€ 28,96800	10	€ 50,69400
140200018		G 3/4	100	€ 38,76000	10	€ 67,83000
140200025		G 1	50	€ 46,92000	5	€ 82,11000

SPIE DI LIVELLO LEVEL SIGHT WINDOWS



Codice Code	Modello Model	Filetto Thread	Conf.standard (pz) Standard package (pcs)	Prezzo Unit Price	Conf.mini (pz) Small package (pcs)	Prezzo Unit Price	
140150001	38D Spia livello in alluminio e vetro Sight Glass made of aluminium alloy with glass window	G 1/4	250	€ 2,08580	25	€ 3,64990	
140150003		G 3/8	250	€ 2,34570	25	€ 4,10570	
140150005		G 1/2	100	€ 2,51720	10	€ 4,40510	
140150006		G 3/4	100	€ 2,63900	10	€ 4,61830	
140150007		G 1	50	€ 3,65400	5	€ 6,39450	
140150008		G 1 1/4	25	€ 8,09970	3	€ 14,21000	
140150009		M14x1,5	250	€ 2,23300	25	€ 3,90780	
140150010		M16x1,5	250	€ 2,45630	25	€ 4,29850	
140150011		M18x1,5	100	€ 2,47660	10	€ 4,33410	
140150012		M20x1,5	100	€ 2,59840	10	€ 4,54720	
140150013		M22x1,5	100	€ 2,65930	10	€ 4,65380	
140150020		38D.I Spia livello inox e vetro Sight Glass made of stainless steel with real glass window	G 1/4	100	€ 16,83000	10	€ 22,44000
140150021			G 3/8	100	€ 22,44000	10	€ 32,64000
140150022	G 1/2		50	€ 28,56000	5	€ 49,98000	
140150023	G 3/4		50	€ 36,72000	5	€ 64,26000	
140150024	G 1		25	€ 42,84000	3	€ 74,97000	
140100162	38M Spia di livello in tecnopolimero Oil sight window plastic	G 3/8	300	€ 0,76130	100	€ 1,33250	
140100163		G 1/2	300	€ 0,86100	100	€ 1,50680	
140100164		G 3/4	100	€ 1,16550	10	€ 2,04020	
140100165		G 1	50	€ 1,73250	5	€ 3,03140	
140100172		M 16 X 1,5	250	€ 0,76130	25	€ 1,33250	
140100173		M 18x1,5	250	€ 0,77180	25	€ 1,35030	
140100174		M 20X1,5	250	€ 0,86100	25	€ 1,50680	
140100175		M 22 X 1,5	100	€ 0,88730	10	€ 1,55300	
140100176		M 40 X 1,5	20	€ 2,68700	2	€ 4,70090	
140130010	38M.C Spia di livello a cupola in tecnopolimero Doomed sight window plastic	G 3/8	300	€ 0,63110	30	€ 1,10460	
140130011		G 1/2	300	€ 0,65940	30	€ 1,15290	
140130012		G 3/4	100	€ 0,89250	10	€ 1,56240	
140130013	G 1	50	€ 1,22850	5	€ 2,15040		
140150040	38TL.GA Leveltech in alluminio con visore in vetro Leveltech made of aluminium alloy with glass window	G 1/4	250	€ 2,29390	25	€ 4,01430	
140150041		G 3/8	250	€ 2,56800	25	€ 4,49440	
140150042		G 1/2	100	€ 2,76080	10	€ 4,83140	
140150043		G 3/4	100	€ 3,91790	10	€ 6,85630	
140150044		G 1	50	€ 4,01940	5	€ 7,03400	
140150045		G 1 1/4	25	€ 8,90970	3	€ 15,59240	
140150050	38TL.GO Leveltech in ottone con visore in vetro Leveltech made of brass with glass window	G 1/4	250	upon request	25	upon request	
140150051		G 3/8	250	upon request	25	upon request	
140150052		G 1/2	100	upon request	10	upon request	
140150053		G 3/4	100	upon request	10	upon request	
140150054		G 1	50	upon request	5	upon request	
140150055	G 1 1/4	25	upon request	3	upon request		

SPIE DI LIVELLO
LEVEL SIGHT WINDOWS



Codice Code	Modello Model	Filetto Thread	Conf.standard (pz) Standard package (pcs)	Prezzo Unit Price	Conf.mini (pz) Small package (pcs)	Prezzo Unit Price	
140150100	38TL.PA A Scarico Ideogr.	G 1/4	250	€ 1,03530	25	€ 1,81180	
140150101		G 3/8	250	€ 1,25860	25	€ 2,20260	
140150102	Leveltech in alluminio con visore in plastica	G 1/2	100	€ 1,67480	10	€ 2,93130	
140150103		G 3/4	100	€ 2,23300	10	€ 3,90780	
140150104	Leveltech made of aluminium alloy with plastic window	G 1	50	€ 3,14650	5	€ 5,50640	
140150105		G 1 1/4	25	€ 4,87200	3	€ 8,52600	
140150110	38TL.PO Leveltech in ottone con visore in plastica	G 1/4	250	upon request	25	upon request	
140150111		G 3/8	250	upon request	25	upon request	
140150112		G 1/2	100	upon request	10	upon request	
140150113		G 3/4	100	upon request	10	upon request	
140150114		Leveltech made of brass with plastic window	G 1	50	upon request	5	upon request
140150115			G 1 1/4	25	upon request	3	upon request

VALVOLE UNIDIREZIONALI ONE-WAY VALVE

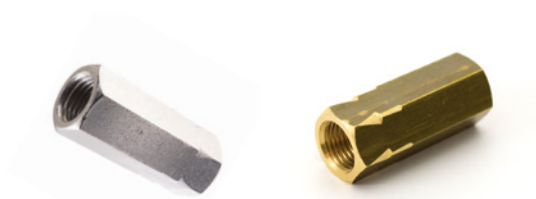

Codice Code	Modello Model	Filetto Thread	Conf.standard (pz) Standard package (pcs)	Prezzo Unit Price	Conf.mini (pz) Small package (pcs)	Prezzo Unit Price
310100003	16C Valvola unidirezionale per pneumatica in ottone nichelato con filetti femmina	G 1/8	250	€ 2,51340	25	€ 4,39850
310100024		G 1/4	250	€ 2,79030	25	€ 4,88300
310100009	Pneumatic one way valve female-female made of nickel plated brass	G 3/8	250	€ 4,51560	25	€ 7,90230
310100017		G 1/2	100	€ 6,56040	10	€ 11,48070
310100002	16C.G Valvola unidirezionale per pneumatica in ottone con filetti femmina	G 1/8	250	€ 2,23650	25	€ 3,91390
310100023		G 1/4	250	€ 2,64120	25	€ 4,62210
310100008	Pneumatic one way valve Female Female made of brass	G 3/8	250	€ 4,30260	25	€ 7,52960
310100016		G 1/2	100	€ 6,21960	10	€ 10,88430
310200004	16D.G Valvola unidirezionale per medie pressioni a doppia tenuta in ottone con filetti femmina	G 1/8	100	€ 4,39100	10	€ 7,68930
310200001		G 1/4	100	€ 6,15040	10	€ 10,76290
310200002	One way valve double seal version female-female made of brass	G 3/8	50	€ 6,59770	5	€ 11,54570
310200003		G 1/2	50	€ 8,64030	5	€ 15,12300
310200013	16D.I Valvola unidirezionale per medie pressioni a doppia tenuta in acciaio inox con filetti femmina	G 1/8	100	€ 13,41060	10	€ 23,47370
310200010		G 1/4	100	€ 17,84480	10	€ 31,22960
310200011	One way valve, double seal version, female-female made of stainless steel	G 3/8	50	€ 19,14260	5	€ 33,49560
310200012		G 1/2	50	€ 26,38860	5	€ 46,18520



SILENZIATORI
SILENCERS

Codice Code	Modello Model	Filetto Thread	Conf.standard (pz) Standard package (pcs)	Prezzo Unit Price	Conf.mini (pz) Small package (pcs)	Prezzo Unit Price
410200024	37A Silenziatore testa esagonale in ottone con filtro di sfere di bronzo sinterizzate Hex head silencer made of brass with sinterized bronze spheres filter	M5	500	€ 0,33230	50	€ 0,56450
410200005		M10X1	250	upon request	25	upon request
410200001		G 1/8	250	€ 0,44300	25	€ 0,75300
410200002		G 1/4	250	€ 0,64220	25	€ 1,09160
410200003		G 3/8	250	€ 0,99680	25	€ 1,69440
410200004		G 1/2	100	€ 1,77220	10	€ 3,01290
410200026		G 3/4	100	€ 2,65820	10	€ 4,51880
410200027	G 1	50	€ 4,09810	5	€ 6,96720	
410200030	37B Silenziatore testa esagonale in ottone con filtro in filo di inox Hex head silencer made of brass with stainless steel wire filter	M5	500	€ 0,42230	50	€ 0,71790
410200006		G 1/8	250	€ 0,42230	25	€ 0,71790
410200007		G 1/4	250	€ 0,61180	25	€ 1,04030
410200008		G 3/8	250	€ 0,94550	25	€ 1,60780
410200009		G 1/2	100	€ 1,22360	10	€ 2,08060
410200028		G 3/4	100	€ 2,33600	10	€ 3,97170
410200029		G 1	50	€ 4,56080	5	€ 7,75380
410400001	37C Silenziatore testa esagonale in ottone con filtro a cono di sfere di bronzo sinterizzate Hex head silencer made of brass with conical sinterized bronze spheres filter	M5	500	€ 0,42070	50	€ 0,71570
410400002		G 1/8	250	€ 0,58680	25	€ 0,99790
410400003		G 1/4	250	€ 0,79770	25	€ 1,35570
410400004		G 3/8	250	€ 1,39520	25	€ 2,37280
410400005		G 1/2	100	€ 2,07140	10	€ 3,52090
410400006		G 3/4	100	€ 4,43040	10	€ 7,53170
410400007		G 1	50	€ 6,86710	5	€ 11,67450
410300011	37D Silenziatore testa zigrinata in ottone con filtro in filo di inox Knurled base silencer made of brass with stainless steel wire filter	M5	500	€ 0,40880	50	€ 0,69550
410300012		G 1/8	250	€ 0,40880	25	€ 0,69550
410300013		G 1/4	250	€ 0,59200	25	€ 1,00600
410300014		G 3/8	250	€ 0,91490	25	€ 1,55560
410300015		G 1/2	100	€ 1,18400	10	€ 2,01310
410300016		G 3/4	100	€ 2,26040	10	€ 3,84300
410300017		G 1	50	€ 4,41320	5	€ 7,50270
410300001	37E Silenziatore testa zigrinata in ottone con filtro di sfere di bronzo sinterizzate Knurled base silencer made of brass with sinterized bronze spheres filter	M5	500	€ 0,33230	50	€ 0,56450
410300002		G 1/8	250	€ 0,44300	25	€ 0,75300
410300003		G 1/4	250	€ 0,64220	25	€ 1,09160
410300004		G 3/8	250	€ 0,99680	25	€ 1,69440
410300005		G 1/2	100	€ 1,77220	10	€ 3,01290
410300006		G 3/4	100	€ 2,65820	10	€ 4,51880
410300007		G 1	50	€ 4,09810	5	€ 6,96720
410300020	37F Silenziatore tutto filetto in ottone con filtro di sfere di bronzo sinterizzate Silencer made of brass conical thread with bronze spheres filter	G 1/8	250	€ 0,48780	25	€ 0,82860
410300021		G 1/4	250	€ 0,54320	25	€ 0,92230
410300022		G 3/8	250	€ 1,10760	25	€ 1,88290
410300023		G 1/2	100	€ 1,38450	10	€ 2,35370
410300024		G 3/4	100	€ 2,49210	10	€ 4,23660
410300025	G 1	50	€ 4,37500	5	€ 7,43800	

SILENZIATORI SILENCERS



Codice Code	Modello Model	Filetto Thread	Conf.standard (pz) Standard package (pcs)	Prezzo Unit Price	Conf.mini (pz) Small package (pcs)	Prezzo Unit Price
410400010	37G Silenziatore in ottone con filtro a cono di sfere di bronzo sinterizzate con chiave Silencer made of brass with conical bronze filter with hex	M5	500	€ 0,42070	50	€ 0,71570
410400011		G 1/8	250	€ 0,53820	25	€ 0,91490
410400012		G 1/4	250	€ 0,73170	25	€ 1,24410
410400013		G 3/8	250	€ 1,23790	25	€ 2,10420
410400014		G 1/2	100	€ 1,82990	10	€ 3,11120
410400015		G 3/4	100	€ 3,87500	10	€ 6,58780
410400016	G 1	50	€ 6,02780	5	€ 10,24750	
410400020	37H Silenziatore in plastica dinamico Silencer plastic dynamic	G 1/8	250	€ 0,43680	25	€ 0,74240
410400021		G 1/4	250	€ 0,54600	25	€ 0,92820
410400022		G 3/8	250	€ 0,98280	25	€ 1,67060
410400023		G 1/2	100	€ 0,98280	10	€ 1,67060
410400024		G 3/4	100	€ 6,55200	10	€ 11,13840
410400025		G 1	50	€ 6,55200	5	€ 11,13840
410200011	37I Silenziatore testa esagonale con rete microforata tutto inox 316L Hex head silencer made of stainless steel AISI 316L with 5 layer net filter	G 1/8	250	€ 5,35600	25	€ 9,10520
410200012		G 1/4	250	€ 6,21300	25	€ 10,56160
410200013		G 3/8	250	€ 8,35540	25	€ 14,20370
410200014		G 1/2	100	€ 14,99680	10	€ 25,49460
410200015		G 3/4	100	€ 25,70880	10	€ 43,70500
410200016		G 1	50	€ 36,42080	5	€ 61,91540
410200017		1/8 NPT	250	€ 5,99870	25	€ 10,19800
410200018		1/4 NPT	250	€ 6,85570	25	€ 11,65450
410200019		3/8 NPT	250	€ 8,99810	25	€ 15,29650
410200020		1/2 NPT	100	€ 16,06800	10	€ 27,31560
410200021	3/4 NPT	100	€ 27,85120	10	€ 47,34700	
410200022	1 NPT	50	€ 39,63440	5	€ 67,37850	
410400030	37L Silenziatore in plastica statico Silencer plastic static	G 1/8	250	€ 0,65520	25	€ 1,11410
410400031		G 1/4	250	€ 0,85160	25	€ 1,44800
410400032		G 3/8	250	€ 1,63800	25	€ 2,78460
410400033		G 1/2	100	€ 1,63800	10	€ 2,78460
410400034		G 3/4	100	€ 6,73790	10	€ 11,45450
410400035		G 1	50	€ 6,73790	5	€ 11,45450
410400040	37M Silenziatore in plastica polietilene Silencer plastic polietilene	M5	500	€ 0,36020	50	€ 0,61220
410400041		G 1/8	250	€ 0,54600	25	€ 0,92820
410400042		G 1/4	250	€ 0,81900	25	€ 1,39230
410400043		G 3/8	250	€ 1,69260	25	€ 2,87700
410400044		G 1/2	100	€ 1,74720	10	€ 2,97050
410400045		G 3/4	100	€ 5,13240	10	€ 8,72550
410400046		G 1	50	€ 8,73600	5	€ 14,85120

RUBINETTI
DRAIN COCKS



Codice Code	Modello Model	Filetto Thread	Conf.standard (pz) Standard package (pcs)	Prezzo Unit Price	Conf.mini (pz) Small package (pcs)	Prezzo Unit Price
420100001	15A	G 1/8	250	€ 0,77400	25	€ 1,35450
420100002	Rubinetto in ottone con tenuta ad OR e con zigrino	G 1/4	250	€ 0,90300	25	€ 1,58030
420100003	Drain cock	G 3/8	250	€ 1,50500	25	€ 2,63380
420100004		G 1/2	100	€ 2,36500	10	€ 4,13880
420100006	15A.A	G 1/8	250	€ 0,86000	25	€ 1,50500
420100007	Rubinetto testa esagonale a OR Ott con zigrino anti svitamento	G 1/4	250	€ 0,96750	25	€ 1,69310
420100008	Drain cock with hand screw system	G 3/8	250	€ 1,61250	25	€ 2,82190
420100005		G 1/2	100	€ 2,48330	10	€ 4,34620
420200010	15B	G 1/4	250	€ 1,12880	25	€ 1,97590
420200011	Rubinetto in ottone con tenuta ad OR e con levetta	G 3/8	250	€ 1,82750	25	€ 3,19810
420200012	Drain cock with lever	G 1/2	100	€ 2,95630	10	€ 5,17400
420200001	15B.A	G 1/4	250	€ 1,20400	25	€ 2,10700
420200008	Rubinetto testa esagonale a OR Ott con levetta anti svitamento	G 3/8	250	€ 1,93500	25	€ 3,38630
420200009	Drain cock with lever	G 1/2	100	€ 3,16050	10	€ 5,53090

RACCORDI FITTINGS



Codice Code	Modello Model	Filetto Thread	Conf.standard (pz) Standard package (pcs)	Prezzo Unit Price	Conf.mini (pz) Small package (pcs)	Prezzo Unit Price
520300015	5.B Riduzione a bicchiere femmina maschio esagonale inox AISI316 Hexagonal glass-shape reduction INOX steel	R 1/8-G 1/4	300	€ 4,15500	30	€ 7,27080
520300016		R 1/4-G 1/4	300	€ 4,15500	30	€ 7,27080
520300017		R 1/4-G 3/8	300	€ 4,95530	30	€ 8,67260
520300018		R 3/8-G 3/8	300	€ 4,95530	30	€ 8,67260
520300019		R 3/8-G 1/2	100	€ 8,77150	10	€ 15,35010
520300020		R 1/2-G 1/2	100	€ 8,77150	10	€ 15,35010
520300021		R 1/2-G 3/4	100	€ 8,84670	10	€ 15,48090
520300022		R 3/4-G 3/4	100	€ 8,84670	10	€ 15,48090
520300023		R 3/4-G 1	50	€ 11,97480	5	€ 20,95640
520300024		R 1-G 1	50	€ 11,97480	5	€ 20,95640
510100011	9.A Nipple maschio-maschio cilindrico acciaio zincato Nipple male male cylindrical thread zinc plated steel	G 1/8-G 1/8	250	€ 0,91910	25	€ 1,60940
510100012		G 1/8-G 1/4	250	€ 1,23480	25	€ 2,16110
510100013		G 1/8-G 3/8	250	€ 1,43870	25	€ 2,51710
510100014		G 1/4-G 1/4	500	€ 0,64380	50	€ 1,12610
510100015		G 1/4-G 3/8	250	€ 0,81350	25	€ 1,42420
510100016		G 1/4-G 1/2	250	€ 1,22960	25	€ 2,15180
510100017		G 3/8-G 3/8	250	€ 0,77000	25	€ 1,34760
510100018		G 3/8-G 1/2	250	€ 0,98840	25	€ 1,72950
510100019		G 3/8-G 3/4	100	€ 1,81640	10	€ 3,17850
510100020		G 1/2-G 1/2	250	€ 0,87150	25	€ 1,52560
510100021		G 1/2-G 3/4	100	€ 1,67150	10	€ 2,92490
510100022		G 1/2-G 1	100	€ 3,19710	10	€ 5,59420
510100023		G 3/4-G 3/4	100	€ 1,27930	10	€ 2,23770
510100024		G 3/4-G 1	100	€ 3,16810	10	€ 5,54350
510100025		G 1-G 1	100	€ 2,68790	10	€ 4,70410
510100027	9.B Nipple maschio-maschio conico ottone nichelato Nipple male male conical thread nickel plated brass	R 1/8-R 1/8	250	€ 0,36300	25	€ 0,63580
510100028		R 1/8-R 1/4	250	€ 0,57530	25	€ 1,00760
510100029		R 1/8-R 3/8	250	€ 0,81950	25	€ 1,43440
510100030		R 1/4-R 1/4	500	€ 0,56650	50	€ 0,99220
510100031		R 1/4-R 3/8	250	€ 0,82390	25	€ 1,44210
510100032		R 1/4-R 1/2	250	€ 1,37720	25	€ 2,41010
510100033		R 3/8-R 3/8	250	€ 0,89100	25	€ 1,55980
510100034		R 3/8-R 1/2	250	€ 1,46740	25	€ 2,56740
510100036		R 1/2-R 1/2	250	€ 1,60270	25	€ 2,80500
510100071	9.C Nipple maschio-maschio cilindrico ottone nichelato Cylindrical nipple MM nickel-plated brass	M5X05-M5X05	300	€ 0,32120	100	€ 0,56100
510100041		G 1/8 - G 1/8	300	€ 0,47520	100	€ 0,83160
510100044		G 1/4 - G 1/4	300	€ 0,72490	100	€ 1,26830
510100070		G 3/8-G 3/8	300	€ 0,97460	100	€ 1,70500
510100050		G 1/2 - G 1/2	300	€ 1,63900	100	€ 2,86880
510100053		G 3/4-G 3/4	100	€ 3,11300	10	€ 5,44720
510100055		G 1-G 1	100	€ 4,43080	10	€ 7,75500

**RACCORDI
FITTINGS**



Codice Code	Modello Model	Filetto Thread	Conf.standard (pz) Standard package (pcs)	Prezzo Unit Price	Conf.mini (pz) Small package (pcs)	Prezzo Unit Price
510100075	9.D Nipple maschio-maschio conico INOX316 Conical nipple MM INOX steel	R 1/8-R 1/8	300	€ 1,95190	30	€ 3,41650
510100076		R 1/4-R 1/4	300	€ 1,95190	30	€ 3,41650
510100077		R 3/8-R 3/8	300	€ 2,25260	30	€ 3,94180
510100078		R 1/2-R 1/2	300	€ 2,35250	30	€ 4,11690
510100079		R 3/4 - R 3/4	100	€ 3,02820	10	€ 5,30040
510100080		R 1-R 1	100	€ 4,17970	10	€ 7,31510
520100009	10.A Riduzione maschio femmina cilindrica acciaio zincato Cylindrical reduction MF galvanized steel	G 1/2-G 3/8	100	€ 0,68620	10	€ 1,20060
520100010		G 3/4-G 1/4	100	€ 1,16230	10	€ 2,03480
520100012		G 3/4-G 1/2	100	€ 0,97390	10	€ 1,70360
520100013		G 1-G 1/4	50	€ 2,21080	5	€ 3,86780
520100015		G 1-G 1/2	50	€ 2,17970	5	€ 3,81500
520100016		G 1-G 3/4	50	€ 2,13620	5	€ 3,73840
520100017	10.B Riduzione maschio femmina conica ottone nichelato Conical reduction MF nickel-plated brass	G 1/4-G 1/8 F	500	upon request	50	upon request
520100019		G 3/8-G 1/4 F	250	€ 0,50300	25	€ 0,88080
520100021		G 1/2-G 1/4 F	250	€ 1,05980	25	€ 1,85370
520100060	10.D Riduzione conica acciaio INOX316 Conical reduction INOX steel	R 1/4-G 1/8	500	€ 1,77680	50	€ 3,10960
520100061		R 3/8-G 1/8	300	€ 2,17740	30	€ 3,81100
520100062		R 3/8-G 1/4	300	€ 2,17740	30	€ 3,81100
520100063		R 1/2-G 1/4	300	€ 2,25260	30	€ 3,94180
520100064		R 1/2-G 3/8	100	€ 2,25260	10	€ 3,94180
520100065		R 3/4-G 1/4	100	€ 3,32900	10	€ 5,82570
520100066		R 3/4-G 3/8	100	€ 3,32900	10	€ 5,82570
520100067		R 3/4-G 1/2	100	€ 3,32900	10	€ 5,82570
520100068		R 1-G 1/2	50	€ 4,17970	10	€ 7,31510
520100069		R 1-G 3/4	50	€ 4,17970	10	€ 7,31510
520200018	10.F Riduzione flangiata maschio femmina cilindrica acciaio zincato Cylindrical flanged reduction MF galvanized steel	G 3/4-G 1/8	100	€ 0,56300	10	€ 0,98430
520200019		G 3/4-G 1/4	100	€ 0,56300	10	€ 0,98430
520200020		G 3/4-G 3/8	100	€ 1,12500	10	€ 1,96860
520200021		G 3/4-G 1/2	100	€ 0,66450	10	€ 1,16330
520200013		G 1-G 1/2	100	€ 0,57960	10	€ 1,01430
520200014		G 1-G 3/4	100	€ 0,80110	10	€ 1,40240
520200015		G 1-G 1/8	100	€ 0,57960	10	€ 1,01430
520200016		G 1-G 1/4	100	€ 0,57960	10	€ 1,01430
520200017		G 1-G 3/8	100	€ 0,57960	10	€ 1,01430
520200002		G 1 1/4-G 3/8	50	€ 1,02150	5	€ 1,78740
520200003		G 1 1/4-G 3/4	50	€ 1,08570	5	€ 1,90030
520200004		G 1 1/4-G 1	50	€ 1,15090	5	€ 2,01410
520200012		G 1 1/4-G 1/2	50	€ 1,01640	5	€ 1,77810
520200008		G 2-G 3/8	50	€ 3,55210	5	€ 6,21620
520200009	G 2-G 1/2	50	€ 3,86990	5	€ 6,77200	
520200010	G 2-G 3/4	50	€ 3,86990	5	€ 6,77200	

RACCORDI FITTINGS



Codice Code	Modello Model	Filetto Thread	Conf.standard (pz) Standard package (pcs)	Prezzo Unit Price	Conf.mini (pz) Small package (pcs)	Prezzo Unit Price	
510100085	10.H Riduzione maschio maschio conica acciaio inox AISI316 Conical reduction MM INOX steel	R 1/4-R 1/8	500	€ 2,58940	50	€ 4,53100	
510100086		R 3/8-R 1/8	300	€ 2,91390	30	€ 5,21180	
510100087		R 3/8-R 1/4	300	€ 2,97880	30	€ 5,21180	
510100088		R 1/2-R 1/4	300	€ 3,26510	30	€ 5,71340	
510100089		R 1/2-R 3/8	100	€ 3,26510	10	€ 5,71340	
510100090		R 3/4-R 1/4	100	€ 4,17970	10	€ 7,31510	
510100091		R 3/4-R 3/8	100	€ 4,17970	10	€ 7,31510	
510100092		R 3/4-R 1/2	100	€ 4,17970	10	€ 7,31510	
510100093		R 1-R 1/2	50	€ 5,38180	10	€ 9,41730	
510100094		R 1-R 3/4	50	€ 5,38180	10	€ 9,41730	
550400001	12A Manicotto femmina femmina cilindrico ottone Sleeve FF cylindrical brass	G 1/8	500	€ 0,49280	50	€ 0,86240	
550400002		G 1/4	250	€ 0,80080	25	€ 1,40140	
550400003		G 3/8	100	€ 1,01200	10	€ 1,77100	
550400004		G 1/2	100	€ 2,10760	10	€ 3,68940	
550400005		G 3/4	50	€ 2,97000	5	€ 5,19640	
530100016	13.A	G 1/8-G 1/8 F	500	upon request	50	upon request	
530100017		G 1/8-G 1/8 F	500	upon request	50	upon request	
530100019		G 1/4-G 1/4 F	250	€ 1,24200	25	€ 2,48400	
530100020		G 1/4-G 1/4 F	250	€ 1,28340	25	€ 2,18180	
530100021		G 1/4-G 1/4 F	100	€ 1,36930	10	€ 2,39600	
530100022		G 3/8-G 3/8 F	250	€ 1,38690	25	€ 2,35770	
530100023		G 3/8-G 3/8 F	250	€ 1,46970	25	€ 2,49850	
530100024		G 3/8-G 3/8 F	100	€ 1,55250	10	€ 2,63930	
530100026		G 1/2-G 1/2 F	100	€ 2,67030	10	€ 4,67410	
530100027		G 1/2-G 1/2 F	50	€ 3,21160	5	€ 5,62110	
540100001	17.A Raccordo maschio femmina a L""	R 1/8-G 1/8 F	100	€ 0,78430	10	€ 1,37170	
540100002		R 1/4-G 1/4 F	100	€ 1,23530	10	€ 2,16260	
540100004		R 3/8-G 3/8 F	100	€ 1,84800	10	€ 3,23400	
540100006	L-shape pneumatic fitting MF	R 1/2-G 1/2 F	100	€ 2,74450	10	€ 4,80260	
540100007	17.B Raccordo femmina femmina a L""	G 1/8-G 1/8 F	100	€ 0,90310	10	€ 1,57960	
540100008		G 1/4-G 1/4 F	100	€ 1,49710	10	€ 2,61910	
540100009		G 3/8-G 3/8 F	100	€ 2,02510	10	€ 3,54310	
540100010		L-shape pneumatic fitting female-female	G 1/2-G 1/2 F	100	€ 2,17800	10	€ 3,81150
540200001	17.C Raccordo femmina femmina femmina a T""	G1/8-G1/8F-G1/8F	100	€ 1,17590	10	€ 2,05810	
540200002		G1/4-G1/4F-G1/4F	100	€ 1,80510	10	€ 3,15810	
540200003		T-shape pneumatic fitting female-female-female	G3/8-G3/8F-G3/8F	100	€ 2,72910	10	€ 4,77620
540200004		G1/2-G1/2F-G1/2F	100	€ 2,13840	10	€ 3,74220	
540200005	17.D Raccordo femmina maschio femmina a T""	R1/8-G1/8F-G1/8F	100	€ 3,12840	10	€ 5,47470	
540200006		R1/4-G1/4F-G1/4F	100	€ 1,94810	10	€ 3,41000	
540200007		R3/8-G3/8F-G3/8F	100	€ 2,59710	10	€ 4,54410	
540200008		T-shpae pneumatic fitting female-male-female	R1/2-G1/2F-G1/2F	100	€ 3,99190	10	€ 6,98500

**RACCORDI
FITTINGS**



Codice Code	Modello Model	Filetto Thread	Conf.standard (pz) Standard package (pcs)	Prezzo Unit Price	Conf.mini (pz) Small package (pcs)	Prezzo Unit Price
540200009	17.E Raccordo maschio femmina femmina a T*** T-shape male -female-female	R1/8-G1/8F-G1/8F	100	€ 1,10440	10	€ 1,93380
540200010		R1/4-G1/4F-G1/4F	100	€ 1,80510	10	€ 3,15810
540200012		R1/2-G1/2F-G1/2F	100	€ 4,46050	10	€ 7,80560
540400002	17.F Raccordo femmina femmina femmina maschio a croce cross shape female-female-female-male	R1/4-G1/4F-G1/4F-G1/4F	100	€ 2,77310	10	€ 4,85320
540400003		R3/8-G3/8F-G3/8F-G3/8F	100	€ 4,13710	10	€ 7,24020
540400004		R1/2-G1/2F-G1/2F-G1/2F	100	€ 6,36790	10	€ 11,14300
540100032	17.G Raccordo maschio maschio a L*** L shaped male-male	M5X0,5C-M5X0,5C	300	€ 0,74800	100	€ 1,31010
540100013		R 1/8-R 1/8	300	€ 0,73700	100	€ 1,28920
540100028		R 1/4-R 1/4	300	€ 1,10440	100	€ 1,93380
540100029		R 1/4-R 1/8	300	€ 0,81950	100	€ 1,43440
540100030		R 3/8-R 3/8	250	€ 1,75780	50	€ 3,07670
540100012		R 1/2-R 1/2	100	€ 2,70820	25	€ 4,73990
540100015		R 3/4 - R 3/4	50	€ 4,01500	10	€ 7,02680
540100031		R 1-R 1	50	€ 6,36790	10	€ 11,14300
540200019		17.H Raccordo maschio maschio maschio a T*** T shaped male-male	R 1/8	300	€ 0,99770	100
540200020	R 1/4		250	€ 1,61590	50	€ 2,82700
540200013	R 3/8		250	€ 2,53000	50	€ 4,42860
540200021	R 1/2		100	€ 3,95560	25	€ 6,92340
540200022	R 3/4		50	€ 5,94000	10	€ 10,39500
540200023	R 1		50	€ 9,44460	10	€ 16,52860
540200025	17.I Raccordo maschio femmina maschio a T*** T shaped male-female	R 1/8-G 1/8	300	€ 1,08130	100	€ 1,89200
540200015		R 1/4-G 1/4	250	€ 1,68740	50	€ 2,95240
540200026		R 3/8-G 3/8	250	€ 2,66090	50	€ 4,65740
540200017		R 1/2-G 1/2	100	€ 4,11070	25	€ 7,19290
540200027		R 3/4-G 3/4	50	€ 6,36790	10	€ 11,14300
540200028	R 1-G 1	50	€ 9,97920	10	€ 17,46360	
540200041	17.L Raccordo femmina maschio maschio a T*** T shaped female-male-male	R 1/8-G 1/8	300	€ 1,11650	100	€ 1,95470
540200016		R 1/4-G 1/4	250	€ 1,90080	50	€ 3,32640
540200042		R 3/8-G 3/8	250	€ 2,73240	50	€ 4,78170
540200043		R 1/2-G 1/2	100	€ 4,31200	25	€ 7,54710
540200044		R 3/4-G 3/4	50	€ 6,38000	10	€ 11,16390
540200028		R 1-G 1	50	€ 9,97920	10	€ 17,46360
540400006	17.M Raccordo femmina femmina femmina femmina a croce female-female	G 1/8	300	€ 1,86560	100	€ 3,26370
540400007		G 1/4	250	€ 3,04150	50	€ 5,32180
540400008		G 3/8	100	€ 4,05130	25	€ 7,08950
540400009		G 1/2	50	€ 6,80680	10	€ 11,91300

FASCETTE, ROTOLINI, PTFE
CABLE TIES, PTFE ROLLS



FASCETTE IN NYLON

NYLON CABLE TIES

Autoestinguenti V2 secondo UL 94. L'aggancio avviene per interferenza del dente elastico della testa sulla cremagliera: una volta inserita la coda nella propria testa si forma un cappio che si può solo stringere. Hanno funzione di fissare o sigillare. Essendo la Poliammide (Nylon) un materiale termoplastico, la sua caratteristica è di essere elastico, cioè di deformarsi sotto sforzo e ritornare alla forma originale quando cessa lo sforzo applicato.

V2 self-extinguishing according to UL 94. The coupling occurs by interference of the elastic tooth of the head on the rack: once the tail has been inserted in its own head, it forms a loop that can only be tighten. They are used for fixing or sealing. The Polyamide (Nylon) is a thermoplastic material, its characteristic is to be elastic, to deform under stress and return to the original shape when the applied force ceases.



FASCETTE NYLON NYLON CABLE TIES



Codice Code	Colore Colour	Misure mm Sizes mm	Ø Max. di Fissaggio Max. Cabling Ø	Confezione Package	Q.tà Q.ty	Prezzo Unit Price
Blue.2.201	natural	75 x 2,5	16	100	2500	€ 0,0126
Blue.2.202	natural	100 x 2,5	24	100	2500	€ 0,0147
Blue.2.203	natural	135 x 2,5	35	100	2500	€ 0,0294
Blue.2.204	natural	160 x 2,5	40	100	2500	€ 0,0336
Blue.2.205	natural	200 x 2,5	55	100	5000	€ 0,0368
Blue.2.210	natural	140 x 3,5	36	100	2500	€ 0,0315
Blue.2.211	natural	200 x 3,5	55	100	2500	€ 0,0473
Blue.2.212	natural	280 x 3,5	80	100	2500	€ 0,0630
Blue.2.214	natural	360 x 3,5	107	100	2000	€ 0,1218
Blue.2.220	natural	140 x 4,5	35	100	2500	€ 0,0452
Blue.2.221	natural	160 x 4,5	40	100	2500	€ 0,0483
Blue.2.222	natural	180 x 4,5	45	100	2500	€ 0,0515
Blue.2.223	natural	200 x 4,5	51	100	2500	€ 0,0557
Blue.2.224	natural	250 x 4,5	73	100	2500	€ 0,0725
Blue.2.425	natural	280 x 4,5	76	100	2500	€ 0,0840
Blue.2.426	natural	360 x 4,5	101	100	2000	€ 0,1134
Blue.2.428	natural	430 x 4,5	130	100	1500	€ 0,1817
Blue.2.447	natural	360 x 6,0	101	100	1000	€ 0,1817
Blue.2.430	natural	180 x 7,5	50	100	1500	€ 0,1313
Blue.2.432	natural	200 x 7,5	52	100	1500	€ 0,1355
Blue.2.431	natural	240 x 7,5	69	100	1000	€ 0,1502
Blue.2.433	natural	280 x 7,5	76	100	1000	€ 0,1628
Blue.2.438	natural	320 x 7,5	88	100	1000	€ 0,1764
Blue.2.434	natural	360 x 7,5	101	100	1000	€ 0,1953

Codice Code	Colore Colour	Misure mm Sizes mm	Ø Max. di Fissaggio Max. Cabling Ø	Confezione Package	Q.tà Q.ty	Prezzo Unit Price
Blue.2.435	natural	450 x 7,5	136	100	1000	€ 0,3045
Blue.2.436	natural	500 x 7,5	145	100	1000	€ 0,3696
Blue.2.441	natural	750 x 7,5	220	100	300	€ 0,5072
Blue.2.450	natural	250 x 12,5	60	50	500	€ 0,3696
Blue.2.451	natural	500 x 12,5	145	50	200	€ 0,6017
Blue.2.452	natural	750 x 12,5	215	50	200	€ 0,7718
Blue.2.453	natural	1000 x 12,5	305	50	200	€ 1,1319
Blue.3.201	black	75 x 2,5	16	100	2500	€ 0,0147
Blue.3.202	black	100 x 2,5	24	100	2500	€ 0,0158
Blue.3.203	black	135 x 2,5	35	100	2500	€ 0,0305
Blue.3.204	black	160 x 2,5	40	100	2500	€ 0,0347
Blue.3.205	black	200 x 2,5	55	100	2500	€ 0,0378
Blue.3.210	black	140 x 3,5	36	100	2500	€ 0,0336
Blue.3.211	black	200 x 3,5	55	100	2500	€ 0,0483
Blue.3.212	black	280 x 3,5	80	100	2500	€ 0,0662
Blue.3.214	black	360 x 3,5	107	100	2000	€ 0,1281
Blue.3.220	black	140 x 4,5	35	100	2500	€ 0,0483
Blue.3.221	black	160 x 4,5	40	100	2500	€ 0,0515
Blue.3.222	black	180 x 4,5	45	100	2500	€ 0,0546
Blue.3.223	black	200 x 4,5	51	100	2500	€ 0,0588
Blue.3.224	black	250 x 4,5	73	100	2500	€ 0,0767
Blue.3.425	black	280 x 4,5	76	100	2500	€ 0,0872
Blue.3.426	black	360 x 4,5	101	100	2000	€ 0,1208
Blue.3.428	black	430 x 4,5	130	100	1500	€ 0,1943

FASCETTE NYLON NYLON CABLE TIES



Codice Code	Colore Colour	Misure mm Sizes mm	Ø Max. di Fissaggio Max. Cabling Ø	Confezione Package	Q.tà Q.ty	Prezzo Unit Price
Blue.3.447	black	360 x 6,0	101	100	1000	€ 0,1911
Blue.3.430	black	180 x 7,5	50	100	1500	€ 0,1386
Blue.3.432	black	200 x 7,5	52	100	1500	€ 0,1407
Blue.3.431	black	240 x 7,5	69	100	1000	€ 0,1565
Blue.3.433	black	280 x 7,5	76	100	1000	€ 0,1743
Blue.3.438	black	320 x 7,5	88	100	1000	€ 0,1869
Blue.3.434	black	360 x 7,5	101	100	1000	€ 0,2058
Blue.3.435	black	450 x 7,5	136	100	1000	€ 0,3192
Blue.3.436	black	500 x 7,5	145	100	1000	€ 0,3875
Blue.3.441	black	750 x 7,5	220	100	300	€ 0,5313
Blue.3.450	black	250 x 12,5	60	50	500	€ 0,3896
Blue.3.451	black	500 x 12,5	145	50	300	€ 0,6353
Blue.3.452	black	750 x 12,5	215	50	300	€ 0,8106
Blue.3.453	black	1000 x 12,5	305	50	300	€ 1,1865

NOTE NOTES

- Carico medio di apertura in daN (1daN=1kg. I valori riportati sono dati medi rilevati a 23°C ± 10% e 50% ± 20% U.R.
- Immagazzinare a temperatura inferiore a 50°C. I valori riportati sono garantiti a 23°C ± 10% e 50% ± 20% U.R.
- Il carico riportato è alla riapertura, secondo il metodo MA C/01 e non il carico di rottura del corpo. Eventuali modifiche di geometria dal prodotto non ne pregiudicano la funzionalità.
- Per la compatibilità chimica, le proprietà elettriche e l'assorbimento d'acqua si fa riferimento alle caratteristiche generali del nylon.
- Average opening load in daN (1daN = 1kg. The values shown are average data recorded at 23°C ± 10% C and 50% ± 20%U.R.
- Store at a temperature below 50 ° C. The values are guaranteed at 23% ± 10% C and 50% ± 20% U.R.
- The load is shown for the reopening, not the body breaking load, according to the method MA C / 01. Any changes of geometry from non product affect the functionality.
- For chemical compatibility, electrical properties and water absorption refer to the general characteristics of the nylon.

ROTOLINI IN PTFE

PTFE ROLLS

Il PTFE ha diverse caratteristiche quali estrema inerzia chimica, eccellente resistenza al calore, nessuna igroscopicità e massima resistenza ai solventi, ottima resistenza all'invecchiamento e minimo coefficiente d'attrito.

Questo prodotto è principalmente utilizzato per tenuta su filetti. Resiste a tutti i composti e solventi chimici noti, ad eccezione del fluoro, del trifluoro di cloro, dei metalli alcalini fusi o in soluzione. Può essere impiegato in un campo di temperatura compreso fra -200 e +240° C, ha un bassissimo coefficiente di attrito, è inodore, insapore ed insolubile.

PTFE's main features are extreme chemical inertness, excellent heat resistance, no hygroscopicity and maximum solvent resistance, excellent resistance to aging and minimum coefficient of friction.

This product is mostly used for thread sealing. It is resistant to all chemical compound and solvent, except for fluoride, alkali metal, melted or in solution. It can be used within a range of temperature from -200° to + 240° C, it has a very low friction impact and It is odourless , tasteless and insoluble.



FASCETTE NYLON

NYLON CABLE TIES

Codice Code	Descrizione Description	Confezione Package	Spessore Thickness	Larghezza Width	Lunghezza Lenght	Prezzo Unit Price
S243901300120	Rotolo PTFE 1/2"	250	0,075	12,0 mm	12 m	€ 0,7875
S243901900120	Rotolo PTFE 3/4"	200	0,075	19,0 mm	12 m	€ 2,0475
M243901900400	Rotolo PTFE 3/4"	30	0,075	19,0 mm	40 m	€ 4,8825
S243901300250	Rotolo PTFE 1"	120	0,075	25,4 mm	12 m	€ 2,3625



MATERIALI PER GUARNIZIONI
SEALING RAW MATERIALS



MATERIALE ESENTE AMIANTO ASBESTOS FREE MATERIAL

CENTELLEN® WS 3820

FOGLI DI GUARNIZIONE UNIVERSALE PER L'IMPIEGO NEL CAMPO DELLE MEDIE TEMPERATURE (DIN 28091 FA-A1-0)
SHEETS FOR UNIVERSAL GASKET USE AT MEDIUM RANGE OF TEMPERATURE (DIN 28091 FA-A1-0)

Il Centellen® WS 3820 è prodotto per calandratura. È costituito da fibre aramidiche nonché da materiali inorganici di rinforzo e contiene gomma NBR come legante.

Resistente a:

- Idrocarburi quali oli e solventi
- Alcoli, glicoli, soluzioni acquose. Acqua e vapore fino a 200°C
- Soluzione alcaline blande e acidi organici

Centellen® WS 3820 is produced through calendaring. It is made of aramid fibres as well as inorganic reinforcing materials and it contains NBR rubber as a binder.

Resistant to:

- Hydrocarbons such as oils and solvents
- Alcohols, glycols, aqueous solutions. Water and steam up to 200°C
- Mild alkaline solution and organic acids

CENTELLEN® WS 3860

QUALITÀ SPECIALE CON OTTIMA RESISTENZA AI REFRIGERANTI
SPECIAL QUALITY WITH EXCELLENT RESISTANCE TO REFRIGERANTS

Il Centellen® NP 3860 è prodotto per calandratura. È costituito da fibre aramidiche nonché da materiali inorganici di rinforzo e, come legante, contiene una speciale miscela di gomme NBR e CR. In fase di produzione i fogli sono dotati di una superficie antiadesiva di piccolo spessore.

Resistente a:

- Refrigeranti quali frigene, freone, cloruro di metilene, ammoniacca o altri.
- Idrocarburi quali oli, glicoli e oli refrigeranti
- Soluzione alcaline blande e acidi organici

Centellen® WS 3860 is produced by calendaring. It consists of aramid fibres as well as inorganic reinforcing materials and it contains a special compound of rubber NBR and CR as a binder. In production phase the sheets are provided with an anti-adhesive surface of small thickness.

Resistant to:

- Refrigerants such frigene, freon, methylene chloride, ammonia or other.
- Hydrocarbons such as oils, glycols and oils refrigerants
- Mild alkaline solution and organic acids

MATERIALE ESENTE AMIANTO WS 3820
ASBESTOS FREE MATERIAL WS 3820



Codice Code	Spessore mm Thickness mm	Descrizione Description	Dimensione lastra mm Sheet size mm	Prezzo mq. Price sq. mt
M011086115000	SPESS. 0,3	CENTELLEN WS3820	1500X4500	€ 41,2965
M011086119000	SPESS. 0,4	CENTELLEN WS3820	1500X4500	€ 53,6550
M011086123000	SPESS. 0,5	CENTELLEN WS3820	1500X4500	€ 55,2090
M011086125000	SPESS. 0,6	CENTELLEN WS3820	1500X4500	€ 80,5665
M011086129000	SPESS. 0,8	CENTELLEN WS3820	1500X4500	€ 83,8530
M011086133000	SPESS. 1,0	CENTELLEN WS3820	1500X4500	€ 104,9895
M011086138000	SPESS. 1,5	CENTELLEN WS3820	1500X1500	€ 157,4895
M011086143000	SPESS. 2,0	CENTELLEN WS3820	1500X1500	€ 170,9400
M011086145000	SPESS. 3,0	CENTELLEN WS3820	1500X1500	€ 252,1995
M011086147000	SPESS. 4,0	CENTELLEN WS3820	1500X1500	€ 374,3985
M011086149000	SPESS. 5,0	CENTELLEN WS3820	1500X1500	€ 467,8905

MATERIALE ESENTE AMIANTO WS 3860
ASBESTOS FREE MATERIAL WS 3860

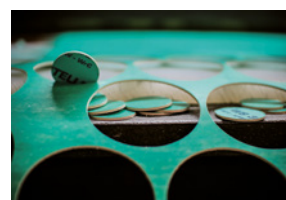

Codice Code	Spessore mm Thickness mm	Descrizione Description	Dimensione lastra mm Sheet size mm	Prezzo mq. Price sq. mt
S011286120000	SPESS. 0,3	CENTELLEN WS3860	1500X1500	€ 43,1970
M011286119000	SPESS. 0,4	CENTELLEN WS3860	1500X1500	€ 54,9255
M011286123000	SPESS. 0,5	CENTELLEN WS3860	1500X1500	€ 60,7530
M011286125000	SPESS. 0,6	CENTELLEN WS3860	1500X1500	€ 73,1115
M011286129000	SPESS. 0,8	CENTELLEN WS3860	1500X1500	€ 85,4700
M011286133000	SPESS. 1,0	CENTELLEN WS3860	1500X1500	€ 101,0625
M011286138000	SPESS. 1,5	CENTELLEN WS3860	1500X1500	€ 144,6690
M011286143000	SPESS. 2,0	CENTELLEN WS3860	1500X1500	€ 188,4435
M011286145000	SPESS. 3,0	CENTELLEN WS3860	1500X1500	€ 282,3450

TABELLA DI COMPATIBILITÀ APPLICATIONS

Tipo di fluido Type of fluid	Centellen WS3820	Centellen NP WS3860
Acqua / Water	A	B
Soluzioni acquose / Aqueous solutions	A	B
Vapore 150°C / Steam 150°C	A	C
Vapore 250°C / Steam 250°C	A	•
Vapore 300°C / Steam 300°C	C	•
Acidi organici / Organic acid	A	•
Acidi inorganici / Inorganic acid	B	•
Acidi ossidanti / Oxidazing acids	C	•
Soluzioni saline / Saline solutions	C	•
Alcoli - Glicoli / Alcohols - glycols	A	D
Aldeidi / Aldehydes	B	C
Chetoni / Ketones	B	C
Esteri / Esters	B	B
Eteri / Ether	A	A
Idrocarburi Alifatici / Aliphatic hydrocarbons	A	A
Idrocarburi Aromatici / Aromatic hydrocarbons	A	A
Idrocarburi Carburanti / Hydrocarbon propellants	A	A
Oli Idrocarburi Alogenati / Halogenated hydrocarbons oils	A	A
Frigorigeni / Refrigerants	B	A
Gas combustibili / Burner gas	A	A
Gas non aggressivi / Non strong gas	A	A
Gas acidi + aggressivi / Acid gas + strong gas	B	B
Ossigeno / Oxygen	A	B

A =Qualità raccomandata / well suited B =Utilizzabile / resistant C =Utilizzabile con limitazioni / partially resistant • =Non adatto / Not resistant

W - WrC
TELL



CARTA OLEORESISTENTE **OIL RESISTANT GASKET PAPER**

Materiale di utilizzo generale prodotto con fibre di cellulosa e plastificanti. È caratterizzato da buona resistenza meccanica e compressibilità, utilizzato come guarnente per oli e combustibili su flange a superficie piana. Colore marrone naturale.

Material for general use produced with cellulose fibres and plasticizers. Characterized by good mechanical strength and compressibility, it is used as seal for oils and fuels on flatbed flanges. Colour: natural brown.



CARTA OLEORESISTENTE
GASKET PAPER OIL RESISTANT

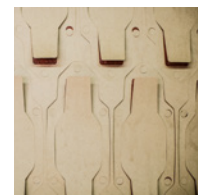

Codice Code	Spessore mm Thickness mm	Descrizione Description	Dimensione rotolo Roll size	Prezzo mq. Price sq. mt
M390380111000	0,2	FLEXOID ROT.H.1000	10 mtr x 1 mtr h.	€ 2,3625
M390080115000	0,3	GUAMOTOR G H.1000	10 mtr x 1 mtr h.	€ 2,8361
M390080123000	0,5	GUAMOTOR G H.1000	10 mtr x 1 mtr h.	€ 4,7303
M390080129000	0,8	GUAMOTOR G H.1000	10 mtr x 1 mtr h.	€ 7,5705
M390080133000	1,0	GUAMOTOR G H.1000	10 mtr x 1 mtr h.	€ 9,4605
M390080138000	1,5	GUAMOTOR G H.1000	10 mtr x 1 mtr h.	€ 14,1960
M390080143000	2,0	GUAMOTOR G H.1000	10 mtr x 1 mtr h.	€ 18,9210
M390080145000	3,0	GUAMOTOR G H.1000	10 mtr x 1 mtr h.	€ 30,0300



COLLANTI
ADHESIVES



ADESIVI CIANOACRILICI CYANOACRYLATE ADHESIVE

Adesivi reattivi, monocomponenti a umido. Reagiscono con l'umidità dei supporti e forniscono un'adesione forte, a rapida presa. È necessario un contatto perfetto fra le due superfici da incollare. Sono disponibili in confezioni da 20-50-500 gr. Si applicano a gocce o cordoli per estrusione diretta dal flacone o con serbatoio sotto pressione e dosatore anche automatizzato o temporizzato.

One-component humidity reactive adhesives. They react to the humidity of the supports providing strong and fast-setting adhesion. It is crucial a perfect contact between the surfaces you need to stick together. They are available in packs of 20-50-500 gr. Applied by dripping or curbs, by direct extrusion from the bottle or pressure tank and dispenser both automated and timed.



ADESIVI CIANOACRILATI CYANOACRYLATE ADHESIVES



Codice Code	Descrizione Description	Confezione Package	Q.tà minima Q.ty minimum	Prezzo Price
S811001100002	SICOMET 85	flacone/ bottle 20 g	20	€ 16,24
S811001100005	SICOMET 85	flacone/ bottle 50 g	10	€ 27,05
S811002100002	SICOMET 7000	flacone/ bottle 20 g	20	€ 18,03
S811002100005	SICOMET 7000	flacone/ bottle 50 g	10	€ 32,14
S811002100050	SICOMET 7000	flacone/ bottle 500 g	1	€ 252,22
S811003100050	SICOMET 99	flacone/ bottle 500 g	1	€ 343,84
S811005100002	SICOMET 63	flacone/ bottle 20 g	20	€ 16,02
S811005100050	SICOMET 63	flacone/ bottle 500 g	1	€ 144,65
S811006100050	SICOMET 8400	flacone/ bottle 500 g	1	€ 212,80
S811008200002	SICOMET TIXOTROPIC	tube/tubetto 20 g	20	€ 24,25
S811010100002	SICOMET 8300	flacone/ bottle 20 g	20	€ 11,48
S811010100005	SICOMET 8300	flacone/ bottle 50 g	10	€ 26,32
S811010100050	SICOMET 8300	flacone/ bottle 500 g	1	€ 182,56
S811012100050	SICOMET 9000	flacone/ bottle 500 g	1	€ 343,84

SICOMET®

ADESIVI CIANOACRILLICI Istantanei

SICOMET 85	Base esterica: metilica / Ester base: methyl Viscosità: 35mPa.s / Viscosity: 35mPa.s	I cianoacrilati a base metallica sono principalmente consigliati per assemblaggi di metalli fra di loro e/o di metalli con altri materiali. Ricordarsi il criterio che a maggior rugosità superficiale deve corrispondere il prodotto a più alta viscosità. The metal based cyanoacrylates are mainly recommended for assemblies of metals between them and/or of metals with other materials. Remember the criterion that a greater surface roughness must match the product with higher viscosity.
SICOMET 7000	Base esterica: metilica / Ester base: methyl Viscosità: 120 mPa.s / Viscosity: 120 mPa.s	
SICOMET 99	Base esterica: metilica / Ester base: methyl Viscosità: 2.000 mPa.s / Viscosity: 2.000 mPa.s	
SICOMET 63	Base esterica: etilica / Ester base: ethyl Viscosità: 80 mPa.s / Viscosity: 80 mPa.s	I cianoacrilati a base etilica sono principalmente consigliati per adesioni tra materie plastiche. Ricordarsi il criterio che a maggior rugosità superficiale corrisponde il prodotto a più alta viscosità. Il SICOMET Tixotrop date le sue peculiari caratteristiche si presta a numerosissimi impieghi ed è adatto per grap notevoli e per assemblaggi verticali. The ethyl based cyanoacrylates are mainly recommended for adhesions between plastics. Remember the criterion that a greater surface roughness must match the product with higher viscosity. Given its peculiar characteristics, SICOMET Tixotrop is used in manly applications and is suitable for large grap and for vertical assemblies.
SICOMET TIXOTROPIC	Base esterica: etilica / Ester base: ethyl Viscosità: Tixotropic / Viscosity: Gel	
SICOMET 8300	Base esterica: etilica superiore / Ester base: alkoxy ethyl Viscosità: 30 mPa.s / Viscosity: 30 mPa.s	I cianoacrilati a base di esteri superiori sono più indicati per adesioni fra elastomeri. Ricordarsi il criterio che a maggior rugosità superficiale deve corrispondere il prodotto a più alta viscosità. The ester based cyanoacrylates are the most suitable for adhesion between elastomers. Remember the criterion that a greater surface roughness must match the product with higher viscosity.
SICOMET 9000	Base esterica: alcossietilica / Ester base: alkoxy ethyl Viscosità: 15 mPa.s / Viscosity: 15 mPa.s	

ADESIVI ANAEROBICI ANAEROBIC ADHESIVES

Adesivi reattivi, monocomponenti a umido. Reagiscono in assenza di ossigeno e per catalisi dei metalli. Per questa loro caratteristica reazione sono indicati in meccanica per il bloccaggio di dadi, prigionieri, cuscinetti, boccole e flange o per la sigillatura di parti piane rettificate. Sono disponibili in flaconi da 50-250 gr o in tubi da 50 e 200 gr. per i tipi più viscosi. Si applicano a gocce o cordoli per estrusione diretta dal flacone o con serbatoio sotto pressione; su superfici piane possono essere applicati per serigrafia, all'interno di collettori o tubazioni cilindriche con rotospray. Si differenziano per viscosità, forza di svitamento e tempo di polimerizzazione.

One-component humidity reactive adhesives. They react in the absence of oxygen and by metal catalysis. Thanks to this characteristics they are suitable in mechanics for locking nuts, studs, bearings, bushings and flanges or for the sealing of flat rectified parts. Available in bottles of 50-250 gr, or 50-200 gr tubes for more viscous types. They can be applied by dripping or curbs, by direct extrusion from the bottle or pressure tank; they can be applied by serigraphy on flat surfaces, within manifolds or cylindrical tubes with Rotospray. They differ between each other for viscosity, strength of unscrewing and polymerization time.

ADESIVI ANAEROBICI ANAEROBIC ADHESIVES



Codice Code	Descrizione Description	Confezione Package	Q.tà minima Q.ty minimum	Prezzo Price
S812006200020	OMNIFIT 100 H	tubetto/tube 200 g	10	€ 158,50
S812005100025	OMNIFIT 100 M	flacone/bottle 250 g	10	€ 149,58
S812010100005	OMNIFIT 200 M	flacone/bottle 50 g	12	€ 38,14
S812010100025	OMNIFIT 200 M	flacone/bottle 250 g	10	€ 149,58
S812013100025	OMNIFIT 230 M	flacone/bottle 250 g	10	€ 82,38
S812016200020	OMNIFIT FD 10	tubetto/tube 200 g	10	€ 130,70
S812017200020	OMNIFIT FD 20	tubetto/tube 200 g	10	€ 78,62
S812024200005	OMNIFIT FD 1042	tubetto/tube 50 g	12	€ 25,26
S812019200020	OMNIFIT 50 H SEAL	tubetto/tube 200 g	10	€ 80,30



100 H/M		<p>Frena filetti medio Bloccaggio di viti, dadi e bulloni a media resistenza. Medium blocker for threads Blocking average resistance screws, nuts and bolts.</p>	<p>Viscosità / Viscosity: 700 mPa.s Gioco massimo / Maximum clearance: 0,04±0,1 mm Resistenza al taglio / Cutting strength: 20 N/mm² Coppia / Torque: 17 N.m Temp. di utilizzo / Working temperature: -60° +150°C</p>
200 M		<p>Frena filetti forte Bloccaggio di filettature in cui sono richieste alte coppie di allentamento. Strong blocker for threads Blocking threads that require high loosening torques.</p>	<p>Viscosità / Viscosity: 700 mPa.s Gioco massimo / Maximum clearance: 0,04±0,1 mm Resistenza al taglio / Cutting strength: 34 N/mm² Coppia / Torque: 28 N.m Temp. di utilizzo / Working temperature: -60° +150°C</p>
230 M		<p>Bloccante per alte temperature Bloccaggio di alberi e boccole, rinforzo e sostituzione di montaggi a pressione longitudinali o trasversali. High temperature blocker Blocking of shafts and bushings, reinforcement and replacement of longitudinal or transversal pressure fittings.</p>	<p>Viscosità / Viscosity: 700 mPa.s Gioco massimo / Maximum clearance: 0,04±0,1 mm Resistenza al taglio / Cutting strength: 40 N/mm² Coppia / Torque: 47 N.m Temp. di utilizzo / Working temperature: -60° +200°C</p>
50 HSeal		<p>Sigillante omologato DIN-DVGW Sigillante ad alta resistenza alla pressione con proprietà antidepositanti e anti sgocciolanti. Disponibile anche in versione 58H più veloce e tenace. Sealant approved DIN-DVGW High pressure resistance sealant with anti-deposit anti dripping features. Also available in 58H version, faster and tenacious.</p>	<p>Viscosità / Viscosity: 700 mPa.s Gioco massimo / Maximum clearance: 0,1±0,15 mm Resistenza al taglio / Cutting strength: 20 N/mm² Coppia / Torque: 20 N.m Temp. di utilizzo / Working temperature: -60° +150°C</p>
FD 1042		<p>Sigillante con TEFLON Sigillatura di flange, giunti e tubazioni soggette a smontaggio e sottoposte a dilatazioni e/o vibrazioni. Contiene TEFLON. TEFLON Sealant Sealing of flanges, couplings and pipes subject to disassembly and to thermal expansion and/or vibration. Contains TEFLON.</p>	<p>Viscosità / Viscosity: Tixotropico Gioco massimo / Maximum clearance: fino a 0,4 mm Resistenza al taglio / Cutting strength: 6 N/mm² Coppia / Torque: 20 N.m Temp. di utilizzo / Working temperature: -60° +150°C</p>
FD 20		<p>Sigillante omologato DIN-DVGW Sigillatura permanente in flange, giunti e tubazioni adatto per grossi raccordi. Sealant approved DIN-DVGW Permanent sealing in flanges, couplings and pipes suitable for large joints.</p>	<p>Viscosità / Viscosity: Tixotropico Gioco massimo / Maximum clearance: fino a 0,25 mm Resistenza al taglio / Cutting strength: 20 N/mm² Coppia / Torque: 20 N.m Temp. di utilizzo / Working temperature: -60° +180°C</p>
FD 10		<p>Sigillante Sigillante di flange, monoblocchi e tubazioni soggette a smontaggio. Sealant Sealing of flanges, monoblocks and pipes subject to disassembly.</p>	<p>Viscosità / Viscosity: Tixotropico Gioco massimo / Maximum clearance: fino a 0,25 mm Resistenza al taglio / Cutting strength: 7 N/mm² Coppia / Torque: 8 N.m Temp. di utilizzo / Working temperature: -60° +180°C</p>

ADESIVO SILICONICO "OMNIVISC 1050" SILICONE ADHESIVE "OMNIVISC 1050"

Sigillante adesivo monocomponente trasparente con elevata adesione su vetro, metalli e materie plastiche. Hanno eccezionali qualità di durata, resistenza all'invecchiamento a basse e alte temperature (oltre 200°C).

Single component transparent adhesive, sealant with high adhesion to glass, metals and plastics and exceptionally long lasting, aging resistant at low and high temperatures (over 200 ° C).

ADESIVO SILICONICO SILICONE ADHESIVE



Codice Code	Descrizione Description	Confezione Package	Q.tà minima Q.ty minimum	Prezzo Price
S819900004165	OMNIVISC 1050	tubetto/tube 90 g	10	€ 40,95

CONDIZIONI GENERALI DI VENDITA

GENERAL TERMS AND CONDITIONS OF SALE

- 1.** I prezzi sono soggetti a variazioni e non sono impegnativi senza conferme d'ordine.

1. Prices may be subject to variations and are not binding, unless confirmed by our Order Confirmation.
- 2.** Indicare negli ordini il codice articolo Athena e il vs codice cliente, onde evitare disguidi ed accelerare le ns. spedizioni. Gli ordini sono validi solo se seguiti da Conferma d'Ordine: Importo minimo fatturabile € 100,00.

2. When placing the order, please mention Athena's item code and your customer code to avoid problems and speed up the shipment process. Orders are only valid if followed by our order confirmation. Minimum billable € 100,00.
- 3.** I termini di consegna indicati si intendono approssimativi e non danno diritto al committente di annullare l'ordine; resta inoltre esclusa ogni ns. responsabilità per danni diretti e indiretti che possano derivare dal ritardo della fornitura.

3. Delivery dates are merely approximate and don't give the customer the right to cancel the order; moreover, we have no responsibility for direct and indirect damages that may occur due to delayed deliveries.
- 4.** Eventuali reclami devono essere segnalati per iscritto entro 8 giorni dal ricevimento della merce. Si precisa che la nostra responsabilità si limita alla pura restituzione dei pezzi che venissero riscontrati difettosi. Resta pertanto esclusa ogni e qualsiasi responsabilità per danni provocati a persone o a cose in conseguenza degli articoli difettosi di cui sopra.

4. Any complaint must be communicated in writing within 8 days the goods have been received by the customer. We specify that our responsibility is restricted to the replacement of faulty goods. Consequently we have no responsibility for damages to persons or things caused by faulty goods.
- 5.** I pagamenti devono essere effettuati entro i termini stabiliti. Trascorse le scadenze convenute verranno conteggiati gli interessi bancari. Si precisa che il ritardato pagamento ci autorizza a sospendere senza alcun preavviso ogni fornitura in corso.

5. Payments must be processed within the agreed terms. If terms are not respected, bank interests will be charged. Delayed payments authorise us to suspend pending orders without notice.
- 6.** In caso di controversia è espressamente riconosciuta la sola competenza del tribunale di Vicenza.

6. In case of dispute, the only competence recognized is Vicenza's court.
- 7.** Athena S.p.a. si riserva la facoltà di cambiare le quote riportate sulle tabelle tecniche, senza preavviso.

7. Athena S.p.a. reserves the right to change dimensions listed in our technical data sheet, without notice.
- 8.** Con l'emissione dell'ordine il committente accetta incondizionatamente le clausole sopra elencate.

8. With the release of the order, the Customer unconditionally accepts the terms and conditions listed above.

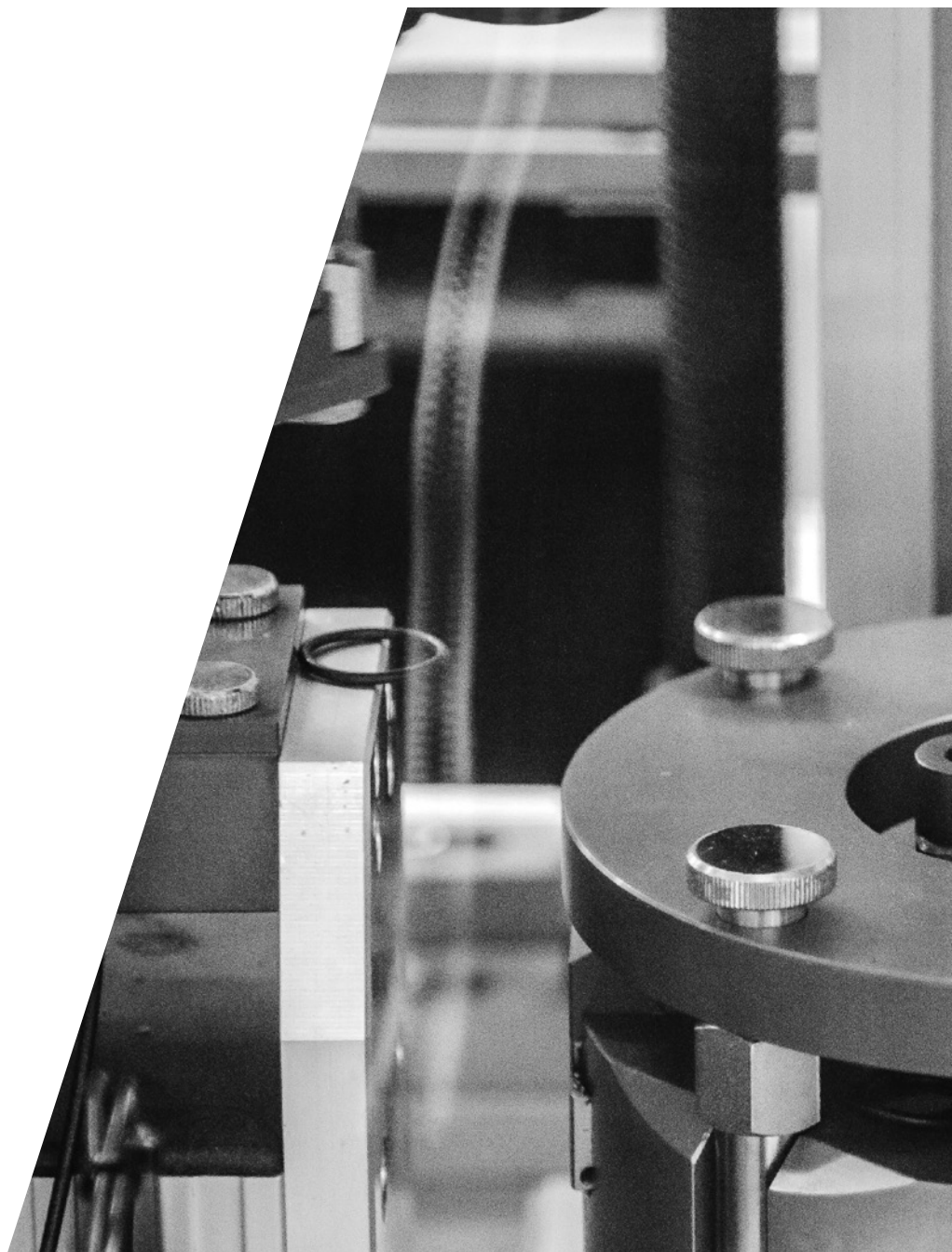

Athena S.p.a.

Via delle Albere, 13

36045 Alonte - Vicenza (Italy)

Ph: +39 0444 727272

Mail: ordini.rivendita@athena.eu

Web: retail.athena.industries